



National  
Defence

Défense  
nationale

**B-GL-321-007/FP-001**

LAND FORCE

# **LAV COMPANY TACTICS (INTERIM) (ENGLISH)**

**(Supersedes B-GL-301-002/FP-001, dated 1989-03-01)**

## **WARNING**

ALTHOUGH NOT CLASSIFIED, THIS PUBLICATION, OR ANY PART OF IT, MAY BE EXEMPT FROM DISCLOSURE TO THE PUBLIC UNDER THE ACCESS TO INFORMATION ACT. ALL ELEMENTS OF INFORMATION CONTAINED HEREIN MUST BE CLOSELY SCRUTINIZED TO ASCERTAIN WHETHER OR NOT THE PUBLICATION OR ANY PART OF IT MAY BE RELEASED.

**Issued on Authority of the Chief of the Land Staff**

**Canada**





National  
Defence

Défense  
nationale

**B-GL-321-007/FP-001**

LAND FORCE

# **LAV COMPANY TACTICS (INTERIM) (ENGLISH)**

**(Supersedes B-GL-301-002/FP-001, dated 1989-03-01)**

## **WARNING**

ALTHOUGH NOT CLASSIFIED, THIS PUBLICATION, OR ANY PART OF IT, MAY BE EXEMPT FROM DISCLOSURE TO THE PUBLIC UNDER THE ACCESS TO INFORMATION ACT. ALL ELEMENTS OF INFORMATION CONTAINED HEREIN MUST BE CLOSELY SCRUTINIZED TO ASCERTAIN WHETHER OR NOT THE PUBLICATION OR ANY PART OF IT MAY BE RELEASED.

**Issued on Authority of the Chief of the Land Staff**

**OPI: DAD 4**

**2003-10-14**

**Canada**



## FOREWORD

1. B-GL-321-007/FP-001, *LAV Company Tactics (Interim)* is issued on the authority of the Chief of the Land Staff.
2. This publication is effective on receipt and supercedes B-GL-301-002/FP-001 *The Combat Team Command Handbook*.
3. The French version of this publication is B-GL-321-007/FP-002, *Les tactiques de la compagnie du VBL*.
4. Unless otherwise noted, masculine pronouns contained herein refer to both genders.
5. Suggestions for amendment and/or improvement shall be forwarded through normal channels to the the Army Lessons Learned Centre or to the Directorate of Army Doctrine as appropriate.
6. This publication is available electronically on both the Defence Information Network (DIN) and the World Wide Web in the Army Electronic Library. Keyword—Army Electronic Library.

©DND/MDN 2003



## PREFACE

### GENERAL

1. This Interim edition of *LAV Company Tactics* builds upon the previous work of the Infantry School's LAV Implementation Cell and also incorporates many lessons learned from the Mobile Automated Instrumentation Suite (MAIS) Trial conducted in CFB Gagetown. In some areas further information has been inserted, based upon feedback from users or from previous publications such as *The Combat Team Commanders Handbook*. This interim edition supersedes all earlier drafts and is the principal reference for units equipped with the LAV III.

### PURPOSE

2. The purpose of B-GL-321-007/FP-001, *LAV Company Tactics (Interim)*, is to provide LAV equipped units with the low level tactical knowledge that will maximize their effectiveness when fighting the LAV III vehicle.

### DOCTRINAL RELEVANCE

3. *LAV Company Tactics*, along with its complementary manual, B-GL-321-006/FP-001, *Combat Team Operations*, are being produced as interim editions. While the fielding, integration, training, and level of experience with the LAV III continues across the field force, there are many issues yet to be resolved. In the meantime, LAV equipped units shall use *LAV Company Tactics* and *Combat Team Operations* as primary doctrinal guidance for training and operations. Only through application of this doctrine for the tactical employment of the LAV III will we be able to effectively gauge the precision and relevance of these manuals.

4. In the near future, LFDTS will coordinate an Army-wide review of these manuals to include your feedback regarding all aspects of integrating and fighting the LAV III. Following the review process, the manuals will be improved, perhaps integrated into one publication, and will then be produced as final editions. Your assistance in this

process is critical to the success of the review and to the standard of our LAV III doctrine.

5. Feedback on the information contained in these manuals is encouraged and it need not wait until the execution of the formal review process. In this regard, units are asked to submit observations to the Army Lessons Learned Centre or to the Directorate of Army Doctrine as appropriate, which they consider would improve the doctrine contained in either manual.



## TABLE OF CONTENTS

<b>FOREWORD</b> .....	i
<b>PREFACE</b>	
General .....	iii
Purpose .....	iii
Doctrinal Relevance .....	iii
<b>CHAPTER 1 ALL OPERATIONS OF WAR</b>	
<b>ANNEX A LAV STOWAGE PLAN</b>	
Stowage List—LAV III APC .....	43
<b>ANNEX B VISIBILITY</b> .....	49
<b>ANNEX C URBAN OPERATIONS</b>	
Introduction .....	51
<b>APPENDIX 1 LAV COMPANY TACTICS</b> .....	65
Engagement Heights—Tanks and LAVs.....	65
<b>ANNEX D NINE RULES TO HELP STAY ALIVE WITH THE LAV III</b> .....	67
<b>CHAPTER 2 OFFENCE</b>	
General .....	69
Attacking with Tanks.....	73
Attacking Without Tanks.....	94
<b>CHAPTER 3 DEFENCE</b>	
Area Defence .....	99
Mobile Defence .....	114
<b>ANNEX A LAV RANGE CARD</b> .....	117
<b>CHAPTER 4 DELAY</b> .....	119
<b>CHAPTER 5 TRANSITIONAL PHASES</b>	
Advance to Contact .....	121
Withdrawal .....	124

Relief in Place ..... 135

Passage of Lines ..... 136

**ANNEX A      OBSTACLE HELD-UP AND CONTACT  
                 DRILLS ..... 137**

**CHAPTER 6    ADMINISTRATION**

To be issued..... 171

## LIST OF FIGURES

Figure 1-1: Team Frontal Fire—Edge Adjust .....	9
Figure 1-2: Team Frontal Fire—Centre Adjust.....	9
Figure 1-3: Platoon Frontal Fire.....	10
Figure 1-4: Team Cross Fire—Edge Adjust.....	11
Figure 1-5: Team Cross Fire—Centre Adjust .....	11
Figure 1-6: Platoon Cross Fire .....	12
Figure 1-7: Team Depth Fire.....	12
Figure 1-8: Platoon Depth Fire .....	13
Figure 1-9: Area Suppression Using the “Z” Pattern .....	14
Figure 1-10: Section Vehicle—Mounted Locations .....	25
Figure 1-11: Platoon HQ Vehicle—Mounted Locations.....	27
Figure 1-12: Formations.....	28
Figure 1-13: Central Tire Inflation System Setting Speeds.....	36
Figure 1B-1: Dead Ground for Viewing—Turret Straight Forward.....	49
Figure 1B-2: Dead Ground for Turret Engagements.....	50
Figure 1C-1: Maximum Height of Targets—Urban Operations .....	56
Figure 2-1: Action in the Attack Position During the Breaching .....	76
Figure 2-2: Move Through the Obstacle—One Breach .....	77
Figure 2-3: Move Through the Obstacle—Two Breaches .....	78
Figure 2-4: Sample Assault Formation .....	79
Figure 2-5: Left Section Vehicle—Dismounting to the Right .....	81
Figure 2-6: Left Front Platoon Dismounting.....	82
Figure 2-7: Zulu LAVs Behind Dismounted Infantry .....	86
Figure 2-8: Zulu LAVs in Line with the Dismounted Infantry .....	88
Figure 2-9: Zulu LAVs to the Flank(s) .....	91
Figure 2-10: Zulu LAVs Between the Intimate Support Tanks and the Dismounted Infantry .....	93
Figure 2-11: LAV Company Quick Attack.....	97
Figure 2-12: LAV Company Deliberate Attack .....	98
Figure 3-1: Area Defence General Concept .....	100
Figure 3-2: LAV Firing Position Stage 1—Hull-Down Position Only .....	103
Figure 3-3: LAV Firing Position Stage 2—Hull- and Turret- Down Positions.....	103
Figure 3-4: Occupying a Prepared Position .....	105
Figure 3-5: Jockeying to the Right.....	108
Figure 3-6: Mobile Defence General Layout .....	116
Figure 5-1: LAV Company Behind the Tanks in the Advance .....	122

Figure 5-2: LAV Company Using Leap Frog—One Platoon  
Supporting the Other Two ..... 124

Figure 5-3: Dismounted Withdrawal ..... 127

Figure 5-4: Mounted Withdrawal Stages 1 and 2—Single  
Route ..... 130

Figure 5-5: Mounted Withdrawal Stages 1 and 2—Individual  
Zulu Platoon routes ..... 131

Figure 5-6: Mounted Withdrawal Stages 3 and 4—Single  
Route ..... 133

Figure 5-7: Mounted Withdrawal Stages 3 and 4—Individual  
Zulu Platoon Routes ..... 134

Figure 5A-1: Crest Drill—Part 1 ..... 139

Figure 5A-2: Crest Drill—Part 2 ..... 139

Figure 5A-3: Crest Drill—Part 3 ..... 140

Figure 5A-4: Gap Drill—Clear with Dismounted Infantry—Part 1 .... 142

Figure 5A-5: Gap Drill—Clear with Dismounted Infantry—Part 2 .... 142

Figure 5A-6: Gap Drill—Clear with Dismounted Infantry—Part 3 .... 143

Figure 5A-7: Gap Drill—Gap not Cleared with Dismounted  
Infantry—Part 1 ..... 144

Figure 5A-8: Gap Drill—Gap not Cleared with Dismounted  
Infantry—Part 2 ..... 145

Figure 5A-9: Gap Drill—Gap not Cleared with Dismounted  
Infantry—Part 3 ..... 145

Figure 5A-10: Defile Drill—Defile Cleared with Dismounted  
Infantry—Part 1 ..... 148

Figure 5A-11: Defile Drill—Defile Cleared with Dismounted  
Infantry—Part 2 ..... 149

Figure 5A-12: Defile Drill—Defile Cleared with Dismounted  
Infantry—Part 3 ..... 149

Figure 5A 13: Defile Drill—Defile Cleared with Dismounted  
Infantry—Part 4 ..... 150

Figure 5A-14: Defile Drill—Defile not Cleared with Dismounted  
Infantry—Part 1 ..... 152

Figure 5A-15: Defile Drill—Defile not Cleared with Dismounted  
Infantry—Part 2 ..... 153

Figure 5A-16: Defile Drill—Defile not Cleared by Dismounted  
Infantry—Part 3 - Two Vehicles Forward ..... 154

Figure 5A-17: Defile Drill—Defile not Cleared with Dismounted  
Infantry—Part 3—One Vehicle Forward ..... 155

Figure 5A-18: Blind Corner Left/Right Drill—Defile and Blind  
Corner Cleared with Dismounted Infantry—  
Part 1 ..... 157

Figure 5A-19: Blind Corner Left/Right Drill—Defile and Blind Corner Cleared with Dismounted Infantry—Part 2 ..... 157

Figure 5A-20: Blind Corner Left/Right Drill—Defile not Cleared with Dismounted Infantry, Blind Corner Cleared with Dismounted Infantry—Part 1 ..... 159

Figure 5A-21: Blind Corner Left/Right Drill—Defile not Cleared with Dismounted Infantry, Blind Corner Cleared with Dismounted Infantry—Part 2 ..... 160

Figure 5A-22: Blind Corner Left/Right Drill—Defile and Blind Corner not Cleared with Dismounted Infantry—Part 1 ..... 161

Figure 5A-23: Blind Corner Left/Right Drill—Defile and Blind Corner not Cleared with Dismounted Infantry—Part 2 ..... 162

Figure 5A-24: Blind Corner T-Junction Drill—Defile and Blind Corner Cleared with Dismounted Infantry—Part 1 ..... 163

Figure 5A-25: Blind Corner T-Junction Drill—Defile and Blind Corner Cleared with Dismounted Infantry—Part 2 ..... 164

Figure 5A-26: Blind Corner T-Junction Drill—Defile and Blind Corner Cleared with Dismounted Infantry—Part 3 ..... 164

Figure 5A-27: Blind Corner T-Junction Drill—Defile not Cleared with Dismounted Infantry, Blind Corner Cleared with Dismounted Infantry—Part 1 ..... 166

Figure 5A-28: Blind Corner T-Junction Drill—Defile not Cleared with Dismounted Infantry, Blind Corner Cleared with Dismounted Infantry—Part 2 ..... 166

Figure 5A-29: Blind Corner T-Junction Drill—Defile not Cleared with Dismounted Infantry, Blind Corner Cleared with Dismounted Infantry—Part 3 ..... 167

Figure 5A-30: Blind Corner T-Junction Drill—Defile and Blind Corner not Cleared with Dismounted Infantry—Part 1 ..... 168

Figure 5A-31: Blind Corner T-Junction Drill—Defile and Blind Corner not Cleared with Dismounted Infantry—Part 2 ..... 169

Figure 5A-32: Blind Corner T-Junction Drill—Defile and Blind Corner not Cleared with Dismounted Infantry—Part 3 ..... 169

B-GL-321-007/FP-001

Figure 5A-33: Deliberately Emplaced Point Obstacle Drill—  
Part 1 ..... 171

Figure 5A-34: Deliberately Emplaced Point Obstacle Drill—  
Part 2 ..... 171

## CHAPTER 1 ALL OPERATIONS OF WAR

1. **Tasks.** The Light Armoured Vehicle (LAV) III armoured personnel carrier (APC) has three main tasks. In order of priority, these are:

- a. to provide protected transport for the infantry to get them as close as possible to the objective;
- b. to provide fire and other mounted support to dismounted infantry; and
- c. to kill enemy LAVs.

2. **Principles of Employment.** The principles of employment are guidelines, rather than hard and fast rules, designed to assist commanders. They are:

- a. Tanks and mechanized infantry are complementary and normally operate together on the battlefield.
- b. The LAV and its section form a total weapons system. Only when the section is dismounted is the full effectiveness of all the weapons realized.

### NOTE

This principle should not be interpreted to mean that the vehicle and section must always be co-located or engaging the same target. The dismounted section and the vehicle work to a joint aim. The location of each relative to the other, its exact tasks and command relationships will be decided by the commander based on the situation.

- c. The aggressive use of the LAV must be tempered with the knowledge that it does not have the firepower or protection of a tank.

LAV Company Tactics (Interim)

- d. Commanders are at the point they can most influence the battle. Circumstances dictate whether or not they dismount.

3. **Ammunition Selection.** Only two natures of 25 mm ammo can be loaded at any given time. The time necessary to unload one nature and load a new nature (approximately 15 minutes) means that the decision as to what nature is loaded in what bin must be made by the commander before going into action. Capabilities of the rounds are:

- a. **APFSDS-T.** The armour-piercing, fin stabilized, discarding sabot-tracer (APFSDS-T) is a long rod penetrator with high kinetic energy concentrated over a very small surface area. The APFSDS-T has the following capabilities:
  - (1) It has the best penetration of any 25 mm round but not as great behind-armour effects as the frangible, armour piercing, discarding sabot-tracer (FAPDS-T).
  - (2) It will defeat all wheeled APCs, including those with appliqué armour.
  - (3) It will defeat most tracked APCs, including BMP-1 and 2 with appliqué armour.
  - (4) It will defeat most other light armour, including self-propelled guns.
  - (5) It will not defeat any modern NATO or former Warsaw Pact (T-80 and later) main battle tank (MBT) from any angle.
  - (6) It will penetrate the back rear on older (T-72 and older) former Warsaw Pact tanks.



**NOTE**

This penetration will eventually stop the engine, resulting in a mobility kill, but it will not kill the crew or disable the gun.

- b. **FAPDS-T.** Frangible, armour piercing, discarding sabot-tracer (FAPDS-T) has less penetration than APFSDS-T but better behind armour effects. The penetrator is designed to fragment on contact resulting in a shower of high velocity particles. If the FAPDS-T strikes an object such as a trim vane or vehicle skirt before it hits the armour, however, it will fragment in front of the armour and probably be defeated. FAPDS-T has the following capabilities:
- (1) It will defeat all wheeled and most tracked APCs without appliqué armour if it strikes the armour cleanly. It will not defeat appliqué armour.
  - (2) It will defeat most other light armour, including self-propelled guns.
  - (3) It will not penetrate MBTs from any angle.

AMMUNITION	PRIMARY USE	SECONDARY USE	NORMALLY LOADED
<b>APFSDS-T</b>	LAVs	Field Fortifications Anti Air	Primary Bin
<b>FAPDS-T</b>	Field fortifications Anti Air	LAVs	Secondary Bin
<b>HEI-T</b>	Suppression of soft targets beyond coax range	Suppression of soft targets within coax range	As Ordered
<b>7.62 mm COAX</b>	Destruction/ suppression of soft targets to tracer burnout (approx 800 m)	Suppression of soft area targets 800–1,400 m	

4. **Engagement Ranges:**

a. Minimum Distances:

- (1) **Direct Fire.** The LAV with appliqué armour provides frontal protection against BMP-2 30 mm AP (armour piercing) rounds from 800 m and out. It also provides all round protection against 14.5 mm AP from 500 m and out. LAVs should be sited to engage those threats beyond those minimum ranges whenever possible.
- (2) **Indirect Fire.** The LAV’s base armour protects against 155 mm shell splinters at 10 m.

b. Maximum Effective Range—25 mm Cannon:

- (1) The maximum effective range for the APFSDS-T and FAPDS-T is defined as the range at which the LAV should achieve a kill with no more than three 3-round bursts against a fully exposed BMP-2 size target. When firing against hull-down targets, effective ranges are reduced and ammunition expenditure is increased.

	<b>BOTH LAV AND TARGET STATIONARY</b>	<b>TARGET MOVING, LAV STATIONARY</b>	<b>LAV MOVING, TARGET STATIONARY OR MOVING</b>
<b>APFSDS-T</b>	2,200 m	1,800 m	1,600 m
<b>FAPDS-T</b>	1,700 m	1,600 m	1,400 m

- (2) The maximum effective range for the high explosive incendiary-tracer (HEI-T) and coax is defined as the distance at which soft targets can be suppressed.

	<b>POINT TARGETS</b>	<b>AREA TARGETS</b>
<b>HEI-T</b>	2,000 m	2,400 m
<b>COAX</b>	800 m	1,400 m

- (3) Whenever possible, LAVs should be sited, and routes chosen, so as not to expose LAVs to effective enemy fire beyond these maximum distances.

5. **Surveillance and Target Acquisition.** The LAV III turret sensors have the following surveillance and target acquisition (STA) characteristics:

a. **Stationary, Exposed Targets:**

	<b>DETECT</b>	<b>RECOGNIZE</b>	<b>IDENTIFY</b>
Day Sight (Clear daylight conditions)	3,000(+) m	3,000 m	2,800m
Thermal Sight (High thermal contrast, low clutter conditions)	3,000 m	2,000 m	1,200 m
Image Intensifying Sight (Heavy overcast, very low light)	1,500 m	800 m	800 m
Image Intensifying Sight (No overcast, full moon)	Unknown	Unknown	Unknown

b. **Stationary, Cold, Hull-Down, Camouflaged Targets:**

LAV Company Tactics (Interim)

	<b>DETECT</b>	<b>RECOGNIZE</b>	<b>IDENTIFY</b>
Day Sight (Clear daylight conditions)	2,800 m	2,000 m	1,200 m
Thermal Sight (High thermal contrast, low clutter conditions)	2,000 m	1,200 m	600 m
Image Intensifying Sight (Heavy overcast, very low light)	Unknown	Unknown	Unknown
Image Intensifying Sight (No overcast, full moon)	Unknown	Unknown	Unknown

c. **Moving Targets:**

	<b>DETECT</b>	<b>RECOGNIZE</b>	<b>IDENTIFY</b>
Day Sight (Clear daylight conditions)	3,200 m	3,000 m	2,800 m
Thermal Sight (High thermal contrast, low clutter conditions)	3,500 m	2,400 m	1,800 m
Image Intensifying Sight (Heavy overcast, very low light)	1,500 m	800 m	800 m
Image Intensifying Sight (No overcast, full moon)	Unknown	Unknown	Unknown

6. **All Weather Operations:**

- a. The LAV's excellent STA, poor weather, and night capabilities allow mechanized operations to be conducted under most conditions. These capabilities should be exploited, particularly against an enemy with inferior STA capabilities. There are, however, significant limitations on human endurance using TI (thermal imagery) and II (image intensifier) sights, and continuous operations require either the rotation of crews (two crews in each vehicle) or rest periods. Details are at para 21g.—Viewing Aids.

- b. When operating against an enemy with less sophisticated night vision equipment than Canada's, the use of active illumination usually assists the enemy more than it assists Canadian forces.
- c. Even during periods of poor visibility, turret crews should periodically check non-thermal sights as changing conditions (moon coming out from behind clouds, etc.) may make them at least temporarily more effective than thermal.

7. **Priority of Targets.** The default priority of targets is based upon the threat they pose to the LAV and the mission requirements. Targets are engaged in the following priority:

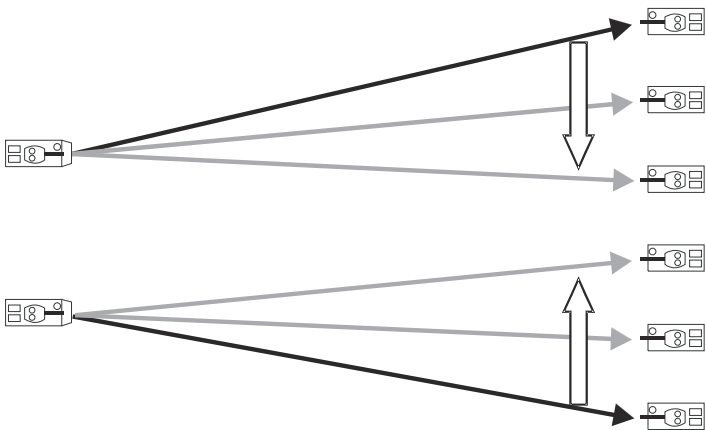
- a. **Most Dangerous Target.** A target with a weapon system that can defeat the LAV and that is engaging or about to engage the LAV.
- b. **Mission Imposed Targets.** Targets that have been ordered as a high priority due to the mission.
- c. **Dangerous Targets.** A target with a weapon system that can defeat the LAV but that is not engaging or about to engage the LAV.
- d. **Least Dangerous Targets.** A target without a weapon system that can defeat the LAV.
- e. **Sub Categories.** Within each of the above types of Targets, the following sub-priority list is used:
  - (1) close targets are engaged before far targets;
  - (2) stationary targets are engaged before moving targets; and
  - (3) head on targets are engaged before flank targets.

8. **Firing Patterns.** Pre-arranged firing patterns are used to ensure that multiple targets are engaged by multiple LAVs in a fast

LAV Company Tactics (Interim)

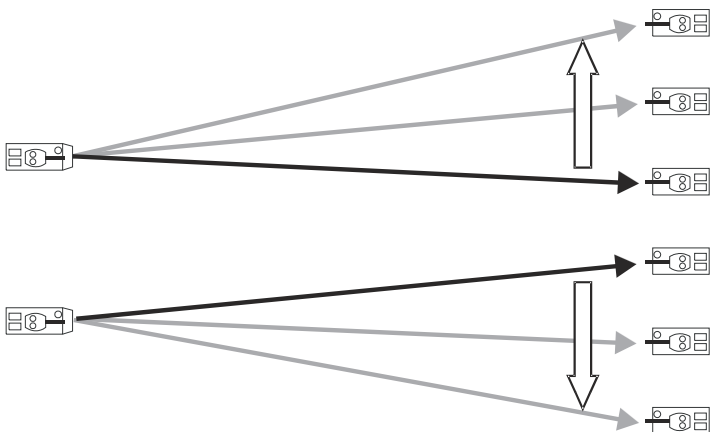
and efficient manner. As with other drills, they provide a workable solution immediately as opposed to a better solution later. As such, they are particularly suited to meeting engagements and hasty ambushes where time for orders and explanations is minimal. While they can be used at higher levels, the patterns are designed for use at the team (two vehicles) and platoon levels. To be effective, the firing patterns require that each crew commander know where his vehicle is in relation to every other vehicle in his team and platoon. The options of edge adjust and centre adjust are chosen based upon the threat. The standard firing patterns are:

- a. **Frontal Fire.** Frontal fire is used to engage multiple targets arranged in a linear manner to the LAVs where good flank shots are not available:
  - (1) **Team.** There are two options for team frontal fire—Edge Adjust and Centre Adjust:
    - (a) **Edge Adjust.** On the command **TEAM FRONTAL FIRE, EDGE ADJUST**, the left-hand LAV starts firing at the left-hand target and works its way towards the centre, and the right-hand LAV starts firing at the right-hand target and works its way towards the centre.



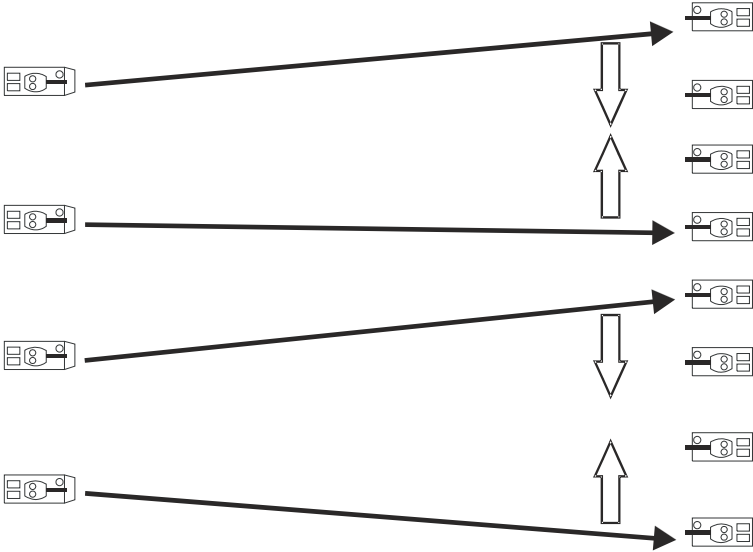
**Figure 1-1: Team Frontal Fire—Edge Adjust**

- (b) **Centre Adjust.** On the command **TEAM FRONTAL FIRE, CENTRE ADJUST**, the left-hand LAV starts firing at the centre target and works its way to the left, and the right-hand LAV starts firing at the centre target and works its way towards the right.



**Figure 1-2: Team Frontal Fire—Centre Adjust**

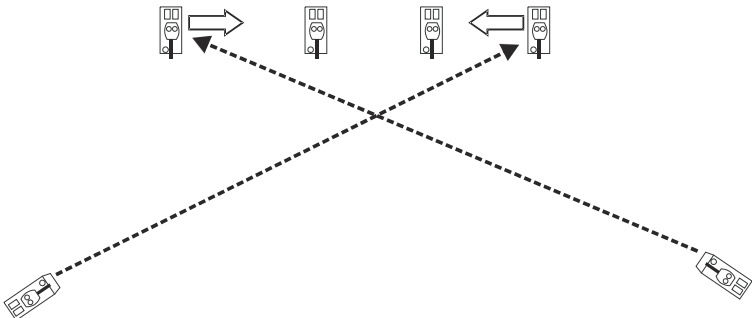
- (2) **Platoon.** On the command **PLATOON FRONTAL FIRE**, the left- and right-hand LAVs use Edge Adjust, and the centre two LAVs use Centre Adjust.



**Figure 1-3: Platoon Frontal Fire**

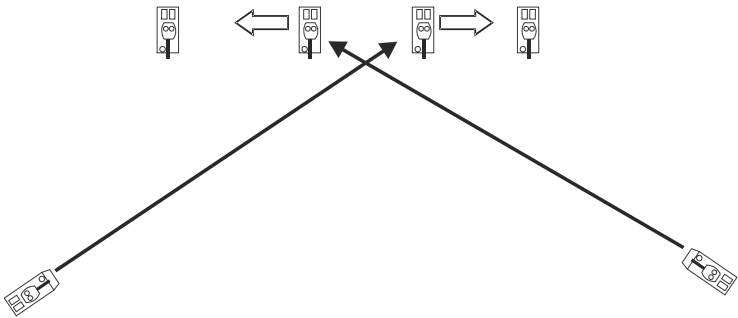
- b. **Cross Fire.** Cross fire is used to engage multiple targets arranged in a linear pattern to the LAVs where good flank shots are available:
  - (1) **Team.** There are two options for team cross fire—Edge Adjust and Centre Adjust:
    - (a) **Edge Adjust.** On the command **TEAM CROSS FIRE, EDGE ADJUST**, the left-hand LAV starts firing at the extreme right-hand target and works its way towards the centre, and the right-hand LAV starts firing at the extreme left-hand target and works its way towards the centre.





**Figure 1-4: Team Cross Fire—Edge Adjust**

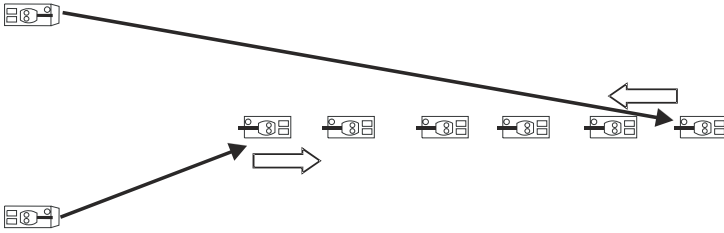
- (b) **Centre Adjust.** On the command **TEAM CROSS FIRE, CENTRE ADJUST**, the left-hand LAV starts firing at the centre target and works its way right, and the right-hand LAV starts firing at the centre and works its way left.



**Figure 1-5: Team Cross Fire—Centre Adjust**

- (2) **Platoon.** On the command **PLATOON CROSS FIRE**, the left-hand LAV starts at the right-hand side using edge adjust, and the right-hand LAV starts at the left side using edge adjust. At the same time, the centre right LAV starts at the centre and works its way left, and the centre left LAV starts at the centre and works its way right.

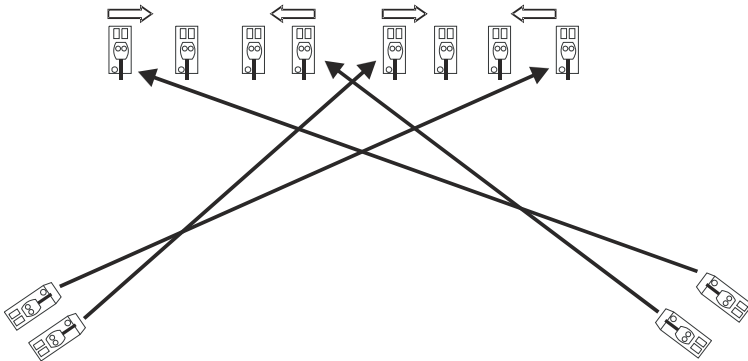
LAV Company Tactics (Interim)



**Figure 1-6: Platoon Cross Fire**

c. **Depth Fire.** Depth fire is used to engage enemy vehicles in column when it is wanted to engage the entire length of the column simultaneously and not to concentrate on the front:

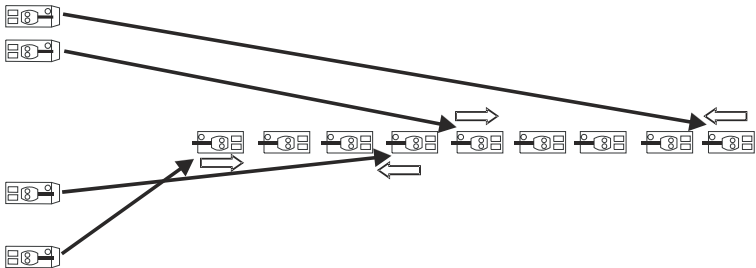
- (1) **Team.** On the command **TEAM DEPTH FIRE**, the left-hand LAV starts at the back end of the column and works its way forward, and the right-hand LAV starts at the front of the column and works its way backward.



**Figure 1-7: Team Depth Fire**

- (2) **Platoon.** On the command **PLATOON DEPTH FIRE**, the left-hand LAV starts at the back end of the column and works its way forward, while the right-hand LAV starts at the front of the column and works its way backward. At the same time, the centre left LAV starts at the centre and

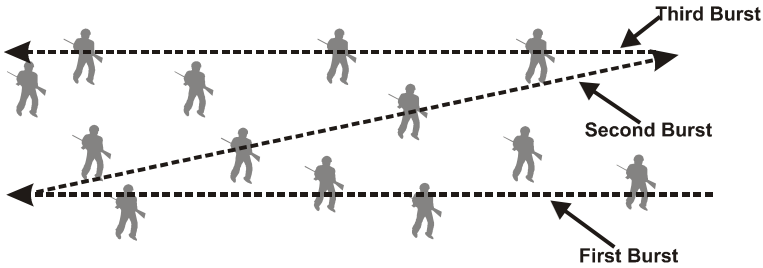
works its way backward, and the centre right LAV starts at the centre and works its way forward.



**Figure 1-8: Platoon Depth Fire**

9. **Area Targets.** Area targets are suppressed using a “Z” pattern out to 1,400 m with the coax and out to 2,400 m using the HEI-T. If the target is large enough that more than one LAV is required to suppress it, the target should be sub-divided between LAVs to ensure proper coverage:

- a. The engagement starts at the front of the target as that is most likely the greatest threat and to take advantage of the HEI-T fragment pattern.
- b. The crew commander chooses which edge the gunner is to start at based on the threat, ease of identification or ease of engagement.
- c. If HEI-T is to be used, as opposed to the coax, the gunner switches to 100 rounds per minute.
- d. The gunner then uses three long bursts—one across the front, one diagonally from the front to the back and one across the back—to suppress the target. The pattern is repeated as required.



**Figure 1-9: Area Suppression Using the “Z” Pattern**

10. **Searching for Targets.** Both the crew commander and the gunner scan within their arcs. Light and obscuration conditions permitting, targets are usually detected easiest and furthest with the TI. They are recognized and identified easiest with the day sight and the II sight. The gunner usually scans using the TI on low magnification and switching to high magnification once a target has been detected. How the crew commander scans depends on the circumstances. Whenever possible, however, two different sensors are used to complement each other.

- a. **Day, No Obscuration, Crew Commander Able to Operate Head Out.** The crew commander and gunner each scan the arcs independently. The crew commander scans head up using binoculars as this is the only method that allows him to quickly scan a wide area both with and without magnification.
- b. **Day, No Obscuration, Crew Commander Not Able to Operate Head Out.** The crew commander scans using the periscopes, switching to the sights when necessary.
- c. **Obscuration, Day or Night.** The crew commander uses the TI on wide field of view along with the gunner.
- d. **Night, No Obscuration.** The crew commander scans using the II sight while the gunner uses the TI.

11. The 5 million candlepower co-axially mounted spotlight with IR filter can be used at night to dramatically extend the effective range of passive II devices. It must be remembered, however, that the spotlight is active and can be detected well beyond the range at which

it can illuminate targets. As with any active illumination source, its use is a command decision.

12. **Target Detection.** When either the crew commander or the gunner detects a target, the following occurs:

- a. A target indication is given. If the target cannot be recognized or identified, the person giving the target indication will state that he cannot recognize or identify the target.
- b. If the target is detected by the gunner and the crew commander is operating heads up, the crew commander aligns himself with the gun barrel and attempts to detect the target using binoculars. If the crew commander is operating hatches down, he uses the sight appropriate to the conditions.
- c. If the target is detected by the crew commander, he roughly aligns the turret to the target and, simultaneously, issues a target indication. The gunner automatically places the appropriate aiming mark on the target, begins to track and reports **ON**.

13. **Target Engagement:**

- a. The crew commander is responsible for ensuring that targets engaged are enemy and of the appropriate type. His decision is based on a combination of situational awareness (where are friendly forces and could some of them be in the area of the target?) and his confidence in his ability to identify the target. In circumstances where the crew commander has good overall situational awareness, such as an area defence where all friendly covering forces have been withdrawn, he may be able to fire on recognition (APC, tank, truck, etc.) only. In circumstances of where his overall situational awareness is lower, such as a meeting engagement, he probably has to first identify the target (BMP-2, T-72, etc.). The situation is worsened in coalition operations, where similar

LAV Company Tactics (Interim)

equipment may be used on both sides. Regardless, once the crew commander has made the decision to fire, he issues the standard fire order using the acronym GRIT:

- (1) **Group.** 25 mm ammunition type or coax. For example, **SABOT**.
  - (2) **Range.** Either estimated, battle or lazed. For example, **BATTLE**.
  - (3) **Indication.** A target description. For example, **BMP LEFT SIDE OF BARN**.
  - (4) **Type of Fire.** Either **FIRE** for a point target or **Z PATTERN, FIRE** for an area target.
- b. The crew commander maintains overall responsibility for the engagement. It is the crew commander's responsibility absolutely to ensure that the gunner is laid on and does engage the correct target. Once the crew commander is confident of this, however, he can concentrate on other things such as the next target, the friendly call signs, the next bound, etc. and not on supervising the gunner, unless the gunner is experiencing difficulty. In particular, if:
- (1) the gunner reports **NOT SEEN** after a burst, the crew commander observes the strike of the next burst and gives the adjustments to the gunner; and
  - (2) after three bursts the gunner has still not reported **TARGET DESTROYED**, the crew commander determines the problem and intervenes as required.
- c. Once the target has been destroyed, the crew commander either brings the gunner onto the next target or orders him to **TRAVERSE YOUR ARCS**.

14. **Ammunition Reload.** The section in the back of the vehicle must be prepared to hand forward linked ammunition to refill the primary ready bin. If there are no troops in the rear of the vehicle, the primary bin is replenished in the same manner as the secondary bin. The secondary bin is refilled by the crew commander with the turret rotated to the 4 o'clock position because it cannot be replenished from the back. The ammunition, if left on the floor, is exposed to dirt and grit that may cause the cannon to jam. It cannot, therefore, be readied before it is needed. The procedure is as follows:

- a. The crew commander orders the linking, the type, and the number of rounds in groups of 15 (for example, **LINK, SABOT, 45**). The executive **LINK** is given first so that the gunner cannot confuse the command to link ammo with a fire order.
- b. The commander in the back orders the correct number and nature of ammunition unboxed, verifies both the number and nature are correct, and supervises its being linked. The ammunition must be protected from dirt and grit.
- c. The ammunition is then laid across the laps of the section members ready to be fed forward through the gap. The end of the belt to be fed through the gap first must be **SINGLE LINK UP, PROJECTILE TO THE RIGHT**. This allows the belt to be loaded into the bin first and then either linked to the existing belt or fed into the forwarder.
- d. When the crew commander is ready to replenish the ready bin, he locks the turret and orders the belt forwarded through the gap in the sequence of executive, type and number. As with the command to link, the executive is given first so it cannot be confused with a fire order (for example, **LOAD, SABOT, 45**).
- e. The commander in the back:
  - (1) confirms the correct type and number;

## LAV Company Tactics (Interim)

- (2) confirms the correct link is up and the projectile is pointing to the right;
  - (3) opens the gap; and
  - (4) drapes the end of the belt over the edge of the gap.
- f. The crew commander, with the assistance of the gunner if practical, loads the belt into the bin and attaches the two belts together.

### WARNING

Both the turret crew and the soldiers in the back must ensure that they do not put their hands through the gap in the turret basket guard. If someone's hand were to be caught by a traversing turret, it could be cut off.

15. **Company Communications.** High tempo operations require the use of an all informed company net. For mounted operations, this results in one company command net being established from section to company commander. For dismounted operations, a second net will usually have to be established as the sections' light assault radios cannot frequency hop. Dismounted platoon and company commanders maintain two nets on two different radio types:

- a. a fixed frequency dismounted net on the light assault radio; and
- b. a frequency-hopping vehicle net on the man-packed AN/PRC-522.

16. **Command Relationships.** The LAV is the section's vehicle. When the section is mounted, the LAV is commanded by the section commander, who normally commands from the turret. When the section dismounts, however, there are various command options. Whichever option is chosen, it must be explicitly stated in orders to avoid confusion:

- a. **Zulu LAVs OPCOM to the Section Commander.** Each dismounted section is supported, individually, by its own LAV. The crew commander directs his



LAV IAW the orders he has received from the dismounted section commander. This method provides the most immediate fire support to the sections but has several disadvantages:

- (1) **Communications:**
  - (a) **Frequency Hopping versus Fixed Frequencies.** In circumstances where the enemy has an electronic warfare capability, vehicle mounted radios normally operate in frequency hopping mode and cannot communicate with the sections' light assault radios. The company (or combat team) must switch to the fixed frequency net before the dismount.
  - (b) **Net Congestion.** The addition of nine dismounted sections to the company (or combat team) net increases net congestion.
- (2) **Lack of Fire Coordination.** With each Zulu LAV looking after its own section, it is very difficult to concentrate fire from several vehicles on a key spot.
- (3) **Lack of Protection for Zulu LAVs.** With each Zulu LAV operating independently of the other Zulu LAVs, there is no ability to use fire and movement. This increases their vulnerability.
- (4) **Lack of Flexibility.** Zulu LAVs individually tasked to individual sections are very difficult to regroup and reorganize to meet an unexpected threat or exploit an opportunity.

- b. **Zulu LAVs OPCOM to the Platoon Commander, OPCON to the LAV Sgt.** The platoon commander commands the Zulu platoon through the LAV Sgt. The platoon commander provides the overall direction and key tasks. The LAV Sgt provides the detailed coordination to meet those tasks. Key points to consider in this option include:

- (1) **Communications:**
  - (a) There is no need for the company (combat team) to switch to a fixed frequency net on dismount as the platoon commander has a frequency hopping man-pack.
  - (b) The platoon commander must also monitor the sections' fixed frequency net using a second radio. While he has a signaller to assist him, the platoon commander cannot be in constant radio contact with both elements.
- (2) **Responsiveness.** The dismounted platoon is guaranteed responsive support though not necessarily from each rifle section.
- (3) **Coordination.** The fire of more than one Zulu LAV can be quickly coordinated to deal with particularly difficult or dangerous targets.
- (4) **Flexibility.** The Zulu platoon can be quickly redirected to deal with unexpected threats or opportunities.
- (5) **Zulu LAV Protection.** The Zulu platoon can move using internal fire and movement to increase its protection.

- (6) **Span of Control.** While the platoon commander is responsible for both elements, he can concentrate on the dismounted element while the LAV Sgt controls the Zulu LAVs in accordance with the platoon commander's orders.
  - (7) The Zulu platoon is normally controlled in this manner in circumstances where platoon objectives/locations permit the coordinated fire support of the entire Zulu LAV platoon but do not reasonably allow the coordinated fire support from other Zulu LAV platoons.
- c. **Zulu LAVs OPCOM to the Coy Comd, OPCON to the LAV Capt.** The company commander commands the Zulu LAVs through the LAV Capt. The company commander provides the overall direction and key tasks. The LAV Capt provides the detailed coordination to meet those tasks. This may include providing Zulu platoons OPCON to rifle platoons but, unlike the above, this support may be withdrawn at any time. Key considerations include:
- (1) **Communications:**
    - (a) There is no requirement for the company (combat team) to switch to a fixed frequency on dismount.
    - (b) There is the least net congestion as the platoon commanders can concentrate on the section battle with the light assault radios.
  - (2) **Responsiveness.** Fire support to individual platoons is not guaranteed.
  - (3) **Coordination.** The fire support of the maximum number of vehicles can be coordinated on the most dangerous or difficult targets.

LAV Company Tactics (Interim)

- (4) **Flexibility.** Entire Zulu platoons can be quickly reoriented to meet unexpected threats and opportunities. Additionally, this is the lowest level of command where a Zulu LAV reserve is expected to be established.
- (5) **Zulu LAV Protection.** It is when operating as a single, coordinated organization that the Zulu LAVs are best able to protect themselves through the use of ground, fire and movement.
- (6) **Span of Control.** While the company commander is responsible for both elements, he can concentrate on the dismounted element while the LAV Capt controls the Zulu LAVs in accordance with the company commander's orders. At the platoon level, the platoon commander can concentrate on the dismounted battle.
- (7) Zulu LAVs are normally controlled in this manner in circumstances where the fire support of the Zulu company as a whole should be coordinated.

- d. **Zulu LAVs Independently Commanded by the LAV Capt or Sgt.** Zulu LAVs may be independently commanded by the LAV Capt or Sgt in circumstances where they are required to act independently of the dismounted element. Tasks such as delay (while the dismounted company is digging in) or exploitation would use this command structure. The lowest level at which Zulu LAVs would normally be tasked independently of the dismounted element is the Zulu platoon.

17. **Chain of Command.** When a commander becomes a casualty, it can cause a significant loss of momentum and increase of friendly casualties as the organization either stops and waits for direction that is not coming or carries on with inappropriate actions.

The next in the chain of command must take over as quickly as possible and ensure that the organization knows that he has taken over. Unfortunately, battle is often such that subordinates cannot see that the commander has become a casualty. In an effort to ensure that positive control is maintained, the following SOP may be adopted:

- a. If the commander, at whatever level, does not respond to the radio twice in a row, he is assumed to be a casualty. As an example, call sign (C/S) 11 calls C/S 19 and offers a SITREP. C/S 19 does not respond. C/S 11 offers the SITREP again and C/S 19 still does not respond. C/S 19 is assumed to be a casualty.
- b. Call sign 1A, who is monitoring, comes up on the net and assumes command. If C/S 1A does not come up automatically and assume command, then C/S 11 calls CS 1A, explains that C/S 19 is not on the air, and recommends the C/S 1A assumes command.
- c. If C/S 1A cannot be reached, then the next in the chain of command automatically takes command, in this case C/S 1B.

18. **Section Command Structure.** There are three command positions within the section:

- a. **Section Commander.** The section commander is crew commander qualified. When the vehicle is moving, he usually commands from the right-hand seat in the turret. He may or may not lead the dismounted element. If he does dismount, his position in the turret is taken by the section 2IC. If the section commander does not dismount, he commands the Zulu LAV.
- b. **Section 2IC.** The section 2IC is crew commander qualified. When the vehicle is moving, he is usually in the rear. If the section commander dismounts, the section 2IC replaces him in the turret. If the section

LAV Company Tactics (Interim)

commander does not dismount, the 2IC commands the dismounted section.

- c. **Section 3IC.** The section 3IC is not necessarily crew commander qualified and always dismounts with the section.

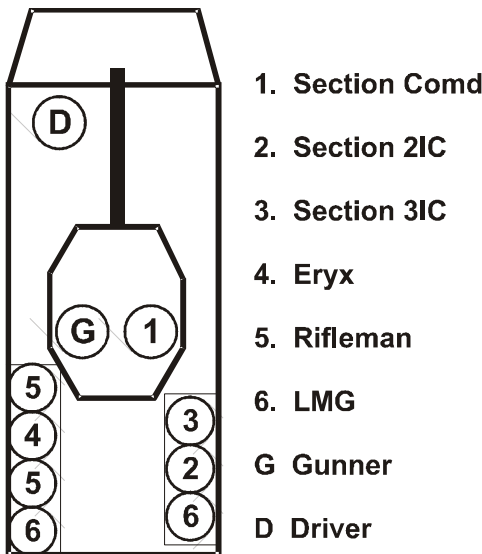
19. **Dismounting in Contact with the Enemy.** Dismounting while in contact with the enemy is conducted as either a deliberate or a hasty action as follows:

- a. **Deliberate Dismount.** In this circumstance, the commander knows in advance that he is going to dismount in contact with the enemy and will usually know where and when. An example of this would be the dismount that precedes the fight through the objective in either a hasty or a deliberate attack. The commander has the ability to reorganize the personnel within the LAV in preparation for the dismount. Specifically, he ensures that the commander he wants to lead the dismounted element has moved to the back and the commander he wants to command the vehicle has moved to the turret. This occurs while the vehicle is out of contact, normally at the RV.
- b. **Hasty Dismount.** In this circumstance, the commander does not know in advance that he is going to be required to dismount in contact. An example of this would be the normal immediate reaction drills to an ambush. It is essential to both keep the gun in action and to dismount the section immediately. In a hasty dismount there is no changing of command positions within the vehicle: the commander in the turret remains there and the commander in the back leads the dismounted element.

20. **Personnel Locations Inside the LAV III.** Section, platoon and company commanders normally command from the right-hand side of the turret. If they are dismounting to lead operations on the ground, they move to the rear of the vehicle and are replaced in the

turret. Due to the necessity of taking the turret out of action when changing personnel, the change around normally takes place before the dismount. Positions in the back of the vehicles described below are recommended and can be changed depending on the circumstances:

- a. **Section Vehicle—Mounted Locations.** When the section is expected to remain mounted, the section commander usually occupies the right-hand turret seat to maintain maximum situational awareness. The section 2IC usually sits in the rear at the middle right, where he has the best access to the crew situational awareness monitor (CSAM), control integration (CI) and TacNav. The section 3IC sits beside him. The section C9 gunners sit beside the ramp where they can:
- (1) be the first personnel out of the vehicle on the dismount, and
  - (2) act as sentries in the rear cargo hatches and be attached to the rear CI.



**Figure 1-10: Section Vehicle—Mounted Locations**

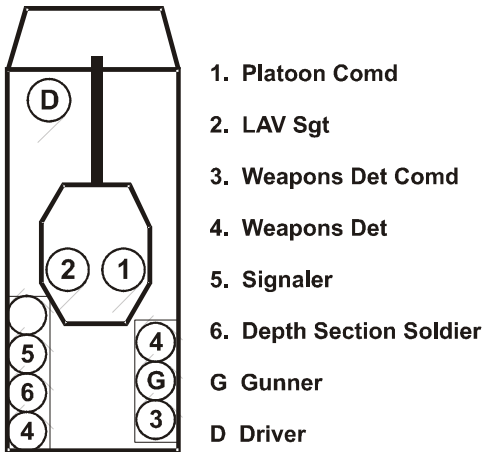
- b. **Section Vehicle—Dismount Locations.** If the section commander is going to dismount, before doing so, he moves to the rear of the vehicle and is replaced in the turret by the section 2IC. The only change in the back is the section commander takes the section 2IC's seat. If possible, this change is made via the cargo and turret hatches as this is much faster than going through the hole in the turret basket guard. Regardless, the crew commander locks the turret before the change around to prevent injury.

**NOTE**

During training, consideration should be given to placing the platoon commander and 2IC in the same vehicle until each is familiar with the other.

- c. **Platoon Commander Vehicle—Mounted Locations.** When the platoon is expected to remain mounted, the platoon commander occupies the right-hand seat in the turret. The LAV Sgt occupies the left-hand seat, acts as the platoon commander's gunner, and is in a position where he is fully current with the situation. The platoon 2IC rides in the back of the Charlie C/S and, if that section is fully up to strength, one soldier from that section rides in the platoon HQ vehicle. The gunner sits in the middle right seat, where he can maintain situational awareness and listen via the CI.





**Figure 1-11: Platoon HQ Vehicle—Mounted Locations**

- d. **Platoon HQ Vehicle—Dismount Locations.** Before the dismount, the platoon commander moves to the rear of the vehicle and takes the gunner’s seat, the LAV Sgt takes the platoon commander’s place, and a gunner moves up from the back. If at all possible, this change around is done externally, using the turret and cargo hatches as this is much faster than going through the hole in the turret basket guard. Regardless, the turret is locked by the platoon commander before the change around begins and is not unlocked by the LAV Sgt until the change around is completed.

21. **Movement.** The LAV company moves using a variety of different techniques depending on the composition of friendly forces, threat, ground and speed required

- a. **Formations.** There are no additions to the basic formations used for mechanized movement. Given the firepower of the vehicle and its STA capabilities, however, the formations may be more spread out than before.

LAV Company Tactics (Interim)

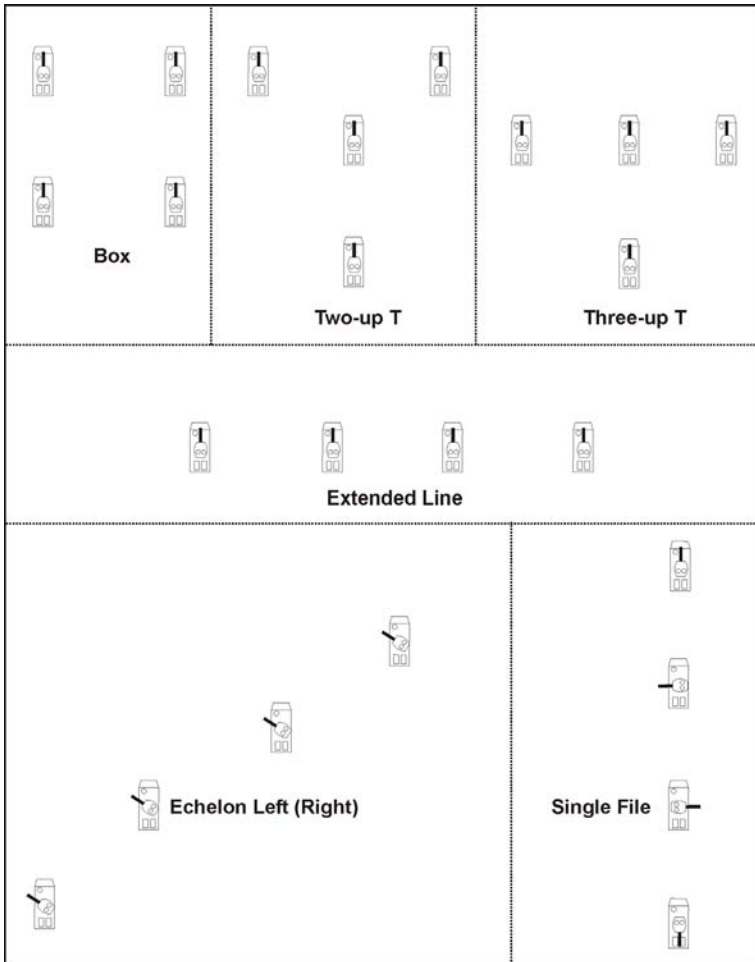


Figure 1-12: Formations

- b. **Maximum Distance Between LAVs.** Whenever practical, vehicles should be spread out to lessen the danger from indirect fire. Commanders, however, must be constantly alert to ensure that they do not inadvertently spread out or lengthen bounds to the point where vehicles can no longer support one another.
  
- c. **Commanders Heads Up / Heads Down.** Crew commanders usually operate heads up as this is the

most effective way of maintaining situational awareness. When commanders must operate heads down, movement rates and vehicle spacing are likely to have to be reduced. See Annex B, Visibility to this section.

- d. **Movement with Tanks.** There is no change to the drill of tanks leading mechanized infantry in open country and dismounted infantry leading tanks in close country. The LAV company behind the tanks can move from position of cover to position of cover or from position of observation to position of observation. The LAV company is far more capable than an M-113 or Grizzly company, however, in providing flank security and all-arms air defence (AAAD) on the move. See Section 5, Advance to Contact with Tanks, for details.
- e. **Direct Fire Support.** The LAV company is organized to provide, if necessary, its own internal fire support while moving. This fire support can take the form of:
  - (1) **Company Level.** Two platoons can support the move forward of one platoon. Once that bound is complete, the forward platoon can then support the rear two platoons moving forward.
  - (2) **Platoon Level.** Within each platoon, the four LAVs are organized into 2 two-vehicle teams—usually the HQ vehicle and Bravo C/S form one team and the Alpha and Charlie C/Ss form the other. The platoon commander (or if he has dismounted, the LAV Sgt) commands one team and the platoon as a whole. The second team is commanded by the Alpha call sign. Each two-vehicle team is able to support the other team.

- (3) **Team Level.** Each two-vehicle team can conduct its own internal fire and movement under the command of the team leader. See Chapter 5, Advance to Contact Without Tanks, for more details.
- f. **Speed.** The limiting factor determining an organization's overall speed is often the time required to search the ground before the next bound. When actually moving, however:
  - (1) Despite gun stabilization, the vehicle can move faster cross-country than the gunner can track. This maximum speed for the gunner varies depending on the type of terrain. The rougher the terrain, the slower the vehicle must move to allow the gunner to remain effective.
  - (2) The gunner must immediately advise the crew commander if he is no longer able to track. The commander must then decide whether high speed or accurate fire is more important while moving and, if necessary, order the driver to slow down.
- g. **Viewing Aids.** The LAV is provided with a variety of vision aids—TI and II sights, driver's thermal and II goggles. They allow the vehicle to move faster and more safely under certain adverse light conditions than was previously possible. The choice is determined by circumstances. If ambient light conditions are good (under a full moon for example), the naked eye must be considered as an alternative to any viewing aids. If a viewing aid is required, considerations include:
  - (1) **Driver:**
    - (a) **II Goggles.** Under conditions of good ambient light and no obscuration, II goggles provide a

better picture than the thermal viewer and allow the driver to quickly scan from left to right. They require him to operate head out of the hatch, however, which restricts the use of the gun and increases his vulnerability. They also prevent him from seeing his instruments.

- (b) **Thermal Viewer.** The thermal viewer works through most obscurants, during periods of extremely low light and hatches down. Its use does not interfere with the driver's view of his instruments. It prevents him from easily scanning left and right, however. There are also periods most days when low thermal contrast renders the driver's viewing aid ineffective.

(2) **Crew Commander:**

- (a) **II Goggles.** If light conditions prevent the crew commander from using the naked eye, II goggles provide the next best method of maintaining overall visual situational awareness. In addition to the benefits and problems above, they do not come close to matching the range of the gunner's thermal sight. The crew commander often cannot detect targets until they are very close. If the gunner detects a target, the crew commander is unlikely to see it through the II goggles. The crew commander must then make a decision whether he will allow the gunner to shoot without the

crew commander verifying the target or if he will remove the goggles and verify the target—a time consuming process. The circumstances do not absolve the crew commander of his accountability if he does not verify the target and the gunner shoots a friendly vehicle.

- (b) **Thermal Sight.** If light conditions do not permit the use of II goggles, or if the commander must operate hatches down, he is restricted to the same arc as the gunner.

- (3) The 5 million candlepower, co-axially mounted spotlight with IR filter can be used at night to dramatically extend the effective range of passive II devices. It must be remembered, however, that the spotlight is active and can be detected well beyond the range at which it can illuminate targets. As with any active illumination source, its use is a command decision.

- h. **Endurance.** The major limiting factor on endurance is the strain placed by the viewing aids on the crewmembers. The second limiting factor is motion sickness for soldiers closed down in the back.

- (1) **Viewing Aids.** The longest that personnel can be expected to remain effective constantly using thermal or II is two hours. After that time they will be ineffective for a prolonged time and can be expected to still have headaches up to eight hours later. For long distance moves, or any other time the sensors must be used for a prolonged period, there are two options:

- (a) A routine of breaks when personnel can look away from the various viewing aids is necessary. Thirty minutes moving followed by 10 minutes stationary is recommended. During the 10-minute break, either the vision aids must go unattended or a temporary substitute must be rotated into those positions.
  - (b) A complete second crew (gunner, driver and crew commander) is carried in the vehicle. This allows the turret crew to be rotated to the back where they can rest their eyes.
- i. **Motion Sickness.** Motion sickness is a problem for some soldiers for prolonged cross-country movement. Breaks in the movement would alleviate the problem.
- j. **Hatches.** The vehicle normally moves tactically with all hatches except the crew commander's closed. This provides:
- (1) unrestricted traverse and firing of the turret;
  - (2) protection to the soldiers from shell fragments;
  - (3) protection to the soldiers from liquid chemical agents;
  - (4) improved effectiveness of the automatic fire explosion suppression system (AFES) if the vehicle armour is penetrated; and
  - (5) maximum speed over rough terrain because the personnel in the back must be sitting not standing.

LAV Company Tactics (Interim)

- k. In circumstances where it is necessary to have additional observation, two personnel can stand in the rear cargo hatches. They should be linked to the intercom system through the rear CI.

22. **TacNav System.** Commanders use the TacNav to assist them in navigation and target location tasks. The aim is to reduce the time taken to perform these tasks, while increasing their accuracy, so that commanders can spend more time concentrating on other aspects of their jobs:

- a. **Responsibilities.** The commander is responsible for navigation. He ensures:
  - (1) the TacNav system has been calibrated and is working properly (see sub-para c below);
  - (2) all waypoints, routes and areas of interest have been input and labelled;
  - (3) all critical areas and lines, with their associated alarms, have been input and labelled;
  - (4) the driver is ordered to use either Steer To or Cross Track modes of navigation; and
  - (5) if the TacNav is operating in Dead Reckoning mode, the location is updated whenever possible using the GPS initialization settings.
- b. **Mode of Navigation:**
  - (1) **Steer To.** Steer To mode gives the commander constant updates on the distance and heading to the waypoint. It does not provide him with a specific route. It is used when the destination is important and it is expected that there will be flexibility in the route. Steer To would



normally be used in operations such as advance to contact.

- (2) **Cross Track.** Cross Track mode keeps the commander to a specific route, defined by a series of waypoints. As every twist and turn of the route must be defined, it is far more time consuming than to program. Cross Track would normally be used for defining routes from the hide to battle positions or when moving through lanes or gaps in obstacles.
- (3) **Assigning Way Points and Routes.** When precision lightweight GPS receivers (PLGRs) are used and a PLGR-to-PLGR data transfer is done, it over-writes the data in the same numbered routes and waypoints in the recipient's PLGR. To avoid this, separate blocks of waypoints and routes should be assigned to subordinate units. With 999 possible waypoints and routes available, this should not cause a problem.

- c. **Checking TacNav Calibration/Function.** The commander must know when the TacNav is no longer properly calibrated or not functioning correctly. A simple way to confirm the function is through use of the far target indicator. The correct functioning of the far target indicator requires that the vehicle's position (GPS or dead reckoning), hull alignment (digital magnetic compass), turret alignment (turret angle encoder), and distance to the target (laser range finder) all must be correctly calculated and processed. To confirm the TacNav calibration/function, the crew commander selects an identifiable point on the ground (within 10 km) and lazies. He then compares the read-out on the TacNav display to the grid from the map. If they are within 100 m for each 1,000 m of distance to the target, the system is probably functioning correctly.

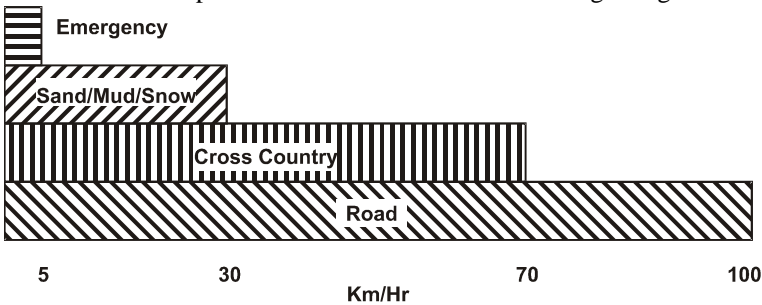
## 23. **Central Tire Inflation System:**

LAV Company Tactics (Interim)

- a. It is the crew commander’s responsibility to order the correct tire setting for the central tire inflation system (CTIS). It is the driver’s responsibility to advise the crew commander when he believes the setting should be changed. Given that changing the CTIS setting has a major effect on the LAV’s speed, the company is usually ordered to adopt one setting, with crew commanders only changing from that setting temporarily to cross particularly difficult terrain.
- b. If the driver attempts to drive too quickly for the setting chosen, the CTIS automatically re-inflates the tires to the minimum safe pressure for that speed. The four settings available, with their maximum speeds, are shown below:

**Figure 1-13: Central Tire Inflation System Setting Speeds**

- c. The CTIS is far more effective in preventing a vehicle from being stuck than it is in getting it unstuck. Crew commanders should order tire pressure to be reduced before entering soft ground.



The reduced tire pressure setting should not be used longer than necessary, however, because it greatly increases the risk of damage to the tire.

- d. When the driver switches from one tire setting to another, the change is not instantaneous and the delay must be taken into account in any time estimate. The times to change from one tire setting to another are as follows:

- (1) approximately 4½ minutes to inflate to the next higher setting; and

- (2) approximately 1½ to 2 minutes to deflate to the next lower tire setting.

24. **Reaction to Vehicle Alarms.** All vehicle alarms give an audible alarm that is repeated through the vehicle intercom. Reaction to these alarms depends on circumstances:

- a. **Engine.** The engine alarm signifies a serious fault that may cause the engine to fail within a short period. If circumstances permit, the crew commander orders the driver to stop and shut off the engine.
- b. **Fire.** The fire alarm and the first shot of the AFES should happen simultaneously. On hearing the fire alarm:
  - (1) The driver stops, if possible.
  - (2) The driver confirms that the first AFES shot has fired. If not, he fires it manually. He then confirms whether the fire is still active. If it is, he fires the second shot manually.
  - (3) The crew commander determines whether the vehicle should be abandoned and gives the appropriate orders.
  - (4) If the vehicle is abandoned, the crew attempts to evacuate taking the manual fire extinguishers with them so that they can continue to fight the fire from the outside. This is only attempted if the extra time needed to get the manual fire extinguishers will not endanger the personnel.
  - (5) Once the fire is extinguished, and assuming the vehicle is still serviceable, it should be properly ventilated.

- c. **Laze.** Even more than most other reactions to alarms, reaction to being lazed depends on the circumstances. The specific circumstances for being lazed while in an area defence are covered in that section. For more general circumstances:
- (1) The laser warning receiver provides information to the crew commander and the driver that:
    - (a) the vehicle has been lazed;
    - (b) whether the laser is eye safe or not;
    - (c) whether the laser is a range finder or a target designator; and
    - (d) the direction of the laze relative to the turret for the crew commander and relative to the hull for the driver.
  - (2) Upon being lazed, the following actions should normally occur:
    - (a) the crew commander should align the turret with the direction of the laze;
    - (b) the gunner should search for and automatically engage any targets in that area; and
    - (c) the driver should search for cover for the vehicle.
  - (3) In addition, the following actions may be taken depending on the circumstances:
    - (a) **Smoke.** The crew commander may fire smoke.

- (b) **Manoeuvre.** The crew commander may order the driver to manoeuvre, either to a location the driver has chosen or to a spot ordered by the crew commander.
- d. **Nuclear, Biological, and Chemical.** Both the GID-3 (one per company) and the AN/VDR-2 (one per platoon) are linked to the vehicle intercom system. On receipt of an NBC alarm, through any means, the following shall occur:
- (1) **Driver.** In this sequence, the driver shall:
    - (a) stop the vehicle;
    - (b) mask;
    - (c) close his hatch (if open);
    - (d) turn off all interior ventilation systems;
    - (e) turn on the ventilated respirator system;
    - (f) put on his NBC suit (if not already on and circumstances permit at that time);
    - (g) hook up his mask to the ventilated respirator system; and
    - (h) prepare to drive.
  - (2) **Crew Commander and Gunner.** In this sequence, the crew commander and gunner shall:
    - (a) mask;
    - (b) close the hatches (if open);
    - (c) put on their NBC suits (if not already on and circumstances permit at that time);

**NOTE**

For the crew commander and gunner to put on their suits while inside the vehicle, they must move to the back of the vehicle via the exit in the turret basket guard. This is a difficult process, particularly for the gunner.

- (d) hook up their masks to the ventilated respirator system; and
  - (e) resume their normal duties.
- (3) **Personnel in the Back.** In this sequence, the personnel in the back shall:
- (a) mask;
  - (b) close the hatches (if open);
  - (c) put on their NBC suits (if not already on); and
  - (d) hook up their masks to the ventilated respirator system.

25. **Smoke.** The LAV III can carry two types of 76 mm smoke grenades for the multi-barrel grenade dischargers (MBGDs)—hexachloroethane (HC) and visual and infrared screening smoke (VIRSS):

- a. **Hexachloroethane Smoke.** Hexachloroethane (HC) smoke screens the LAVs and dismounting troops from most of the enemy's direct fire weapons. At the same time, the LAVs can see and shoot through it using TI. It takes 30 seconds to build, however, and prevents the friendly dismounted troops from being able to see their objectives.
- b. **Visual and Infrared Screening Smoke.** Visual and infrared screening smoke (VIRSS) forms an almost

instantaneous curtain that screens the LAVs and any dismounted troops from all the enemy's weapons and observation devices. However:

- (1) VIRSS is highly toxic. Troops must either wait for it to dissipate or mask before moving forward.
- (2) VIRSS blinds not only the enemy's STA devices but the LAV's as well.





**ANNEX A**  
**LAV STOWAGE PLAN**

**STOWAGE LIST—LAV III APC**

<b>SERIAL</b>	<b>LOCATION</b>	<b>STOWAGE ITEMS</b>
1	Exterior left side, front to rear	-1 x tow cable (14 tonne) -7 x support for camouflage net -1 x crowbar pinch point -2 x tire chains in tire chain compartment -1 x POL Pioneer tool rack with: -1 x axe -1 x mattock pick/handle -2 x round top shovels -1 x bow saw -1 x 5 lb sledge hammer -1 x stretcher -5 x snow shoes (in winter)
2	Exterior rear	-4 x 20 L jerry cans—usually 2 x diesel and 2 x water but may be changed depending on circumstances -1 x tire with bracket and strap -2 x shackles—30 tonne -2 x shackles—12 tonne
3a	ISC only, exterior right side, rear to front	Pioneer tool rack with: -1 x axe -1 x mattock pick/handle -2 x round top shovels -1 x bow saw -1 x 5 lb sledge hammer -2 x tire chains in tire chain compartment -13 x support for camouflage net -5 x snow shoes (in winter)
3b	CP only, exterior right side, rear to front	-1 x antenna group -2 x purloin frame section arches -3 x purloin pole -2 x tire chains in tire chain compartment -13 x support for camouflage net -2 x snow shoes (in winter)
4	Exterior, front	-2 x barbed tape concertina (highway operation) -2 x shackles (30 tonne)



SERIAL	LOCATION	STOWAGE ITEMS
		-12 x C3 para flare -2 x M49 A1 trip flare -signal flares hand : 6 x red 6 x green
9	Inside driver's/crew stowage area	-1 x driver's web gear bag -1 x pamphlet bag Stowage box with: -1 x driver's tool bag -1 x grease gun -1 x spout can flex -1 x hand oiler -1 x siphon -1 x 6v DC lantern -1 x various POL -1 x wire cutters -1 x 5 lb fire extinguisher -3 x rucksacks (driver, gunner, crew comd) -1 x driver's NBC/IPE (individual protective equipment) bag -1 x driver's C7A1 rifle -1 x boresight and container -2 x 20 L water jerry cans (normally carried only in winter instead of external jerry cans but can be in addition depending on circumstances) -1 x gunner NBC/IPE bag
10	Inside compartment, left side, left to right	-1 x crew boiling unit (CBU) -1 x first aid kit (top left) in bag strapped to AFES bottles -1 x 5 lb fire extinguisher (below rear LHS seat back) -4 x rucksack (pouches facing forward). -rations for 24 hours (2 <sup>nd</sup> 24 hrs carried on soldiers) -1 x M2A1 ammo can with: -1 x driver's NVGs -1 x C42 ammo can with: -1 x spot light, battery and equipment issue scale (1 per pl) -1 x battery charger in Pelican case -1 x cargo stowage net complete (for left side)
11	Inside back left seat bin	-2 x ramp safety chains -1 x 25 mm cleaning kit (1 x cleaning rod in 4 sections, 2 x wire brush, 1 x plastic barrel plug) -1 x 76 mm bore brush and cleaning kit -1 x 76 mm circuit tester (1 per pl) -6 x M19A1 ammo boxes of 7.62 mm link -2 x NBC/IPE bags -1 x machete strapped to the seat bin

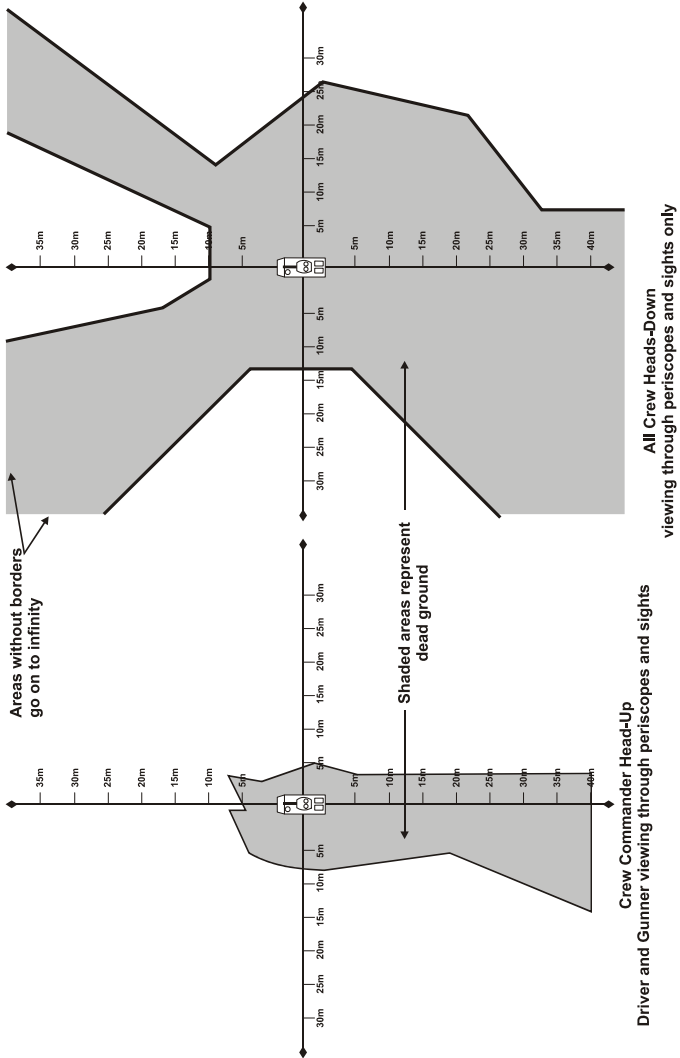
LAV Company Tactics (Interim)

SERIAL	LOCATION	STOWAGE ITEMS
		-1 x ramp vision block cover
12	Inside front left seat bin	-8 x drums (C-9) 5.56 mm in 2 x C42 ammo containers -2 x NBC/IPE bags -5 x skop kit -3 x pairs of wire gloves -1 x asbestos gloves -1 x wire cutter with case
13	Inside front, left to right	-2 x C7A1 left side of turret guard -1 x C7A1 right side of turret guard -7 x 25 mm ammo PA125 ammo containers
14a	Inside compartment, right side, left to right	-1 x crew comd's NBC/IPE bag -1 x AN-VDR 2 (1 x pl) -1 x GID 3 (1 x coy) -1 x battery stowage box -3 x rucksack (pouches facing inside) -1 x cargo stowage net complete (for right-hand side)
14b	Pl Comd's vehicle only	-1 x short-range anti-armour weapon (medium) (SRAAW(M)) 84 mm -6 x SRAAW(M) 84 mm ammo in the containers -3 x bags in the front left seat bin with: -cleaning kit -boresight kit -telescopic/class sight
14c	Sect vehicle only	-2 or 3 x ERYX missile -1 x ERYX system (tripod, firing post and thermal sight)
15	Inside, right seat bin	-8 x drums (C-9) 5.56 mm in 2 x C42 ammo containers -3 x NBC/IPE bags -1 x chemical agent monitor (CAM) (1 per pl) -2,450 rounds 5.56 mm ball
16	Winch kit equipped vehicles only	-1 x winch -1 x snatch block (10 tonne) -1 x master link -1 x shackle (12 tonne) -1 x fairlead -1 x winch controller and extension cable -1 x cleaning brush
17	Gunner's tool rack in turret	-1 x hand crank -1 x screw driver (flat tip 12") -1 x pri bar -1 x pliers, snubnose -1 x ratchet and socket (14 mm)
18	Other	-16 x locks -environmental kit (held by CQ)

SERIAL	LOCATION	STOWAGE ITEMS
19	Combat supplies summary	<p>POL:</p> <ul style="list-style-type: none"> <li>-200 L diesel in vehicle gas tanks</li> <li>-up to 80 L diesel in external jerry cans (if no external water jerry cans carried)</li> <li>-18 L naphtha</li> </ul> <p>Water:</p> <ul style="list-style-type: none"> <li>-up to 120 L in jerry cans (if both external and internal water jerry cans are carried and no external diesel jerry cans are carried)</li> <li>-1 to 3 L per soldier in webbing</li> </ul> <p>Food:</p> <ul style="list-style-type: none"> <li>-24 hrs IMPs (individual meal packs) stowed</li> <li>-24 hrs IMPs in soldiers' rucksacks</li> </ul> <p>Ammo:</p> <ul style="list-style-type: none"> <li>-25 mm</li> <li>210 ready rounds (rds)</li> <li>210 stowed rds</li> <li>-7.62 mm link</li> <li>440 ready rds (coax)</li> <li>1,320 stowed rds</li> <li>880 rds carried by pl wpns det (pl HQ veh only)</li> <li>-5.56 mm link</li> <li>200 ready rds (pintle)</li> <li>3,200 stowed rds</li> <li>1,400 rds carried by sect (sect veh only)</li> <li>-5.56 mm ball</li> <li>2,450 stowed rds</li> <li>2,450 carried by sect pers (350 per soldier with C7 rifle)</li> <li>-grenade, 76 mm (smoke or HE)</li> <li>8 ready rds</li> <li>8 stowed rds</li> <li>-grenade, frag, hand x 12 (stowed)</li> <li>-grenade, hand, smoke x 4 (stowed)</li> <li>-Eryx missiles x 3 (sect veh only) or</li> <li>-84 mm rounds x 6 (pl HQ veh only)</li> <li>-claymore mines x 3</li> <li>-para flare x 12</li> <li>-trip flare x 2</li> <li>-signal flare x 12</li> </ul>



### ANNEX B VISIBILITY



**Figure 1B-1: Dead Ground for Viewing—Turret Straight Forward**

LAV Company Tactics (Interim)

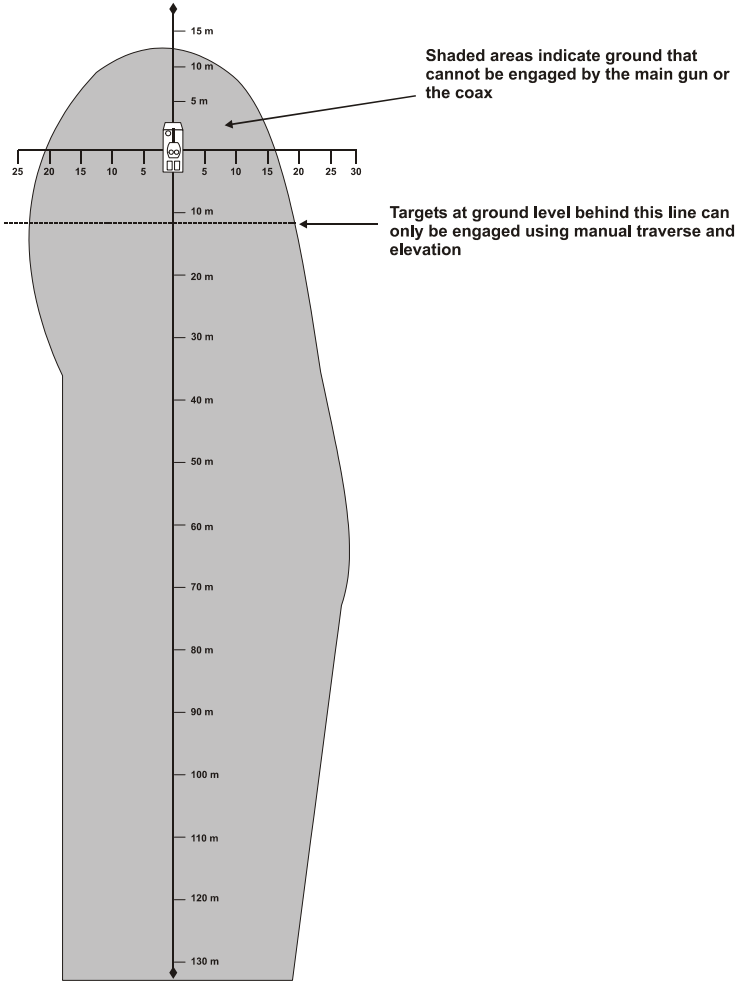


Figure 1B-2: Dead Ground for Turret Engagements



## ANNEX C URBAN OPERATIONS

*It cannot be emphasised too strongly, therefore, that the key to success in urban warfare is good infantry. And the key to good infantry, rather than good weaponry, is a traditional mixture of training, leadership qualities in NCOs and junior officers, and morale—implying a readiness to take casualties.<sup>1</sup>*

### 1. **References:**

- a. B-GL-300-002/FP-000, *Land Force Tactical Doctrine*;
- b. B. US Army FM 3-06.11 (90-10-1) *An Infantryman's Guide to Urban Operations* (Coordinating Draft);
- c. B-GL-322-008/FP-001, *Soldiers Guide for Urban Operations* (Draft).

## INTRODUCTION

2. **Background.** This annex on urban operations is based upon, primarily, the two references; no independent research was completed. The application of the information in the references was refined, however, through the application of the LAV's physical characteristics and the Canadian company structure to the templates provided.

3. **General.** The intent of this annex is to provide guidance on how to use the LAV to support the dismounted company in urban operations. While much of this annex is applicable to tanks as well as LAVs, the Tactics School remains the Centre of Excellence for combined arms warfare. Specific direction on tank-infantry cooperation in an urban environment should be requested from the Tactics School.

---

<sup>1</sup> *The World Turned Upside Down: Military Lessons of the Chechen War*, by Mr. Anatol Lieven

LAV Company Tactics (Interim)

4. **Characteristics and Limitation.** The characteristics and limitations of urban operations, as defined by Land Force tactical doctrine, are listed below. Those characteristics and limitations expected to have particular affect on the use of LAV have been amplified.

a. **Characteristics:**

CHARACTERISTICS	POSSIBLE CONSEQUENCES
Limited fields of fire and observation.	Whether stationary or moving, LAVs are unlikely to be able to see and dominate the approaches to them. Dismounted infantry are likely to be required to cover these approaches and provide close protection.
Protection, cover and concealment for troops and equipment.	Good areas of cover should be available both as waiting areas and fire positions.
Reduced possibilities for manoeuvre, particularly for mechanized units, but increased possibilities for infiltration and bypassing.	LAVs will be unable to manoeuvre tactically in most urban areas and may be unable to negotiate large areas due to rubble or narrow, twisting streets. Dismounted soldiers will be required to protect LAVs from enemy soldiers who have been bypassed or who have infiltrated.
Close-quarter combat including the increased vulnerability of vehicles to short-range attack.	LAVs cannot see or shoot close-in targets at ground level (see Annex B to Chapter 1). Dismounted soldiers will be required to protect the LAV in close quarters.
The presence of a civilian population.	The possibility of civilian casualties and their attendant political consequences can very seriously limit military actions.
Difficulties in command, control and communication.	At company level, commanders are likely to have to be forward with their troops to maintain control. They are unlikely to be able to exercise effective control from the LAV.
Higher rates of consumption of ammunition and combat supplies.	The LAV can be used to bring forward ammunition and other combat supplies. Additional LAV ammunition is likely to be required as the 25 mm cannon will be used in suppression roles with correspondingly higher ammo expenditure rates.
A battle that is likely to be fought on multiple levels: at street level, on rooftops and in buildings and underground in sewers and subway systems.	The LAV's turret is very effective at engaging targets in buildings.

b. **Limitations:**

LIMITATIONS	POSSIBLE CONSEQUENCES
<p><b>Fields of Observation and Fire.</b> Fire positions will be selected to take advantage of the limited observation and fields of fire available.</p>	
<p><b>Information.</b> Detailed knowledge of the area may offer a relative advantage to the defender.</p>	<p>Key positions should be input into the TacNav system, along with both primary and alternate routes.</p>
<p><b>Concealment.</b> Positions are difficult to locate, strengths are hard to estimate, and enemy intentions are hard to define.</p>	<p>Visibility is limited in the LAV, particularly when hatches are closed. Dismounted infantry are likely to be needed to assist in target locating.</p>
<p><b>Movement.</b> The ability to move is generally very limited. The more buildings are damaged, the more cover there is for the defender, and the harder it is for the attacker to advance.</p>	<p>As the urban area becomes damaged, it may be impossible to move LAVs forward to support the advance or to withdraw them from a defensive position.</p>
<p><b>Weapon Employment.</b> Short-range weapons and grenades will be used extensively. Mutually supporting fire will be difficult to achieve. Indirect fire weapons and tanks may be of limited use.</p>	<p>Dismounted infantry will be needed for the close-in protection of the LAV.</p>
<p><b>Fire.</b> Depending upon the construction, building fires may be an important consideration.</p>	<p>25 mm ammunition carries more tracer element than small arms and has, therefore, a greater inherent ability to start fires. Additionally the HEI-T ammo is designed to start fires. This may impose limitations on its use.</p>
<p><b>Stress.</b> Street fighting is physically and mentally exhausting, success being measured in metres, building by building. In these circumstances, much will depend on the initiative and standard of leadership at the lower levels of command. The maintenance of combat efficiency may require the frequent rotation of troops in contact.</p>	

**5. Weaknesses and Strengths of Dismounted Infantry and LAVs.** Because of the decentralized nature of urban combat and the need for a high number of troops to conduct operations in dense, compact terrain, infantrymen will always represent the bulk of forces. At the small-unit tactical level, dismounted infantry forces have disadvantages that can be compensated for by LAVs (and tanks).

LAV Company Tactics (Interim)

Conversely, LAVs (and tanks) face problems in the confines of urban areas that place them at a severe disadvantage when operating alone:

a. **Dismounted Infantry Weaknesses:**

- (1) Infantry forces lack heavy supporting firepower, protection, and long-range mobility.
- (2) Exposed dismounted infantry forces are subject to taking a high number of casualties between buildings.
- (3) Dismounted infantry forces are more subject to fratricide-related casualties from friendly direct and indirect fire.

b. **LAV Weaknesses:**

- (1) Crewmen in LAVs have poor all round vision through their vision blocks; they are easily blinded by smoke or dust. Even when the crew commander is operating head-up, he cannot see close in to his vehicle at ground level. This can make it extremely difficult for the crew commander to direct the gunner onto the target.
- (2) LAVs are noisy compared to dismounted infantry. There is little chance of LAVs arriving in an area undetected.
- (3) Improvised barricades, narrow streets and alleyways or large amounts of rubble can block the LAV's movement.
- (4) If isolated or unsupported by dismounted infantry, LAVs are vulnerable to enemy hunter/killer teams firing light and medium anti-armour weapons as well as less sophisticated weapons such as petrol bombs.

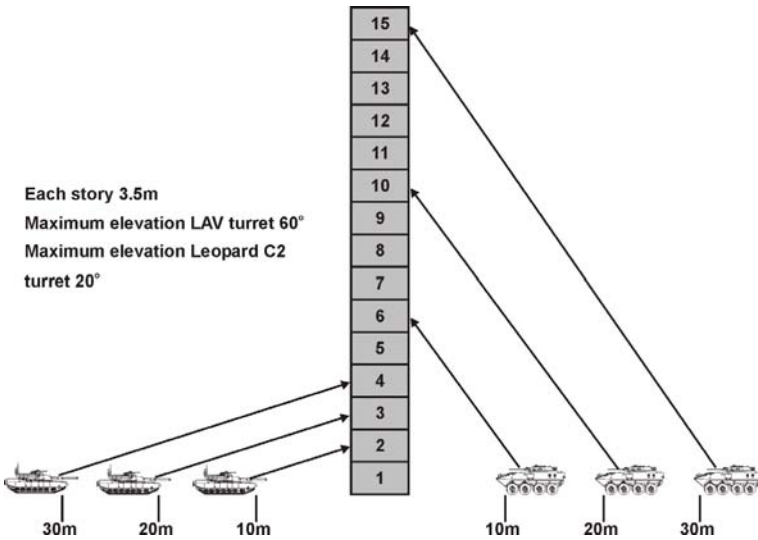
c. **Dismounted Infantry Strengths:**

- (1) Infantry small arms fire within a building can eliminate resistance without seriously damaging the structure.
- (2) Infantrymen can move stealthily into position without alerting the enemy. Infantrymen can move over or around most urban terrain, regardless of the amount of damage to buildings.
- (3) Infantrymen have excellent all round vision and can engage targets with small arms fire under almost all conditions.
- (4) In the end, only infantry can route the enemy out of well-prepared urban battle positions.

d. **LAV Strengths:**

- (1) The thermal sights on LAVs can detect enemy activity through darkness and smoke, conditions that limit even the best-equipped infantry.
- (2) LAVs can deliver devastating fire, are protected against fragments and small arms, and have excellent mobility along unblocked routes.

## LAV Company Tactics (Interim)



**Figure 1C-1: Maximum Height of Targets—Urban Operations**

- (3) LAVs can move mounted infantrymen rapidly to points where, together, they can dominate and isolate the cordoned area. With their long-range sights and weapons, LAVs can dominate large expanses of open area and thus free infantry to isolate closer terrain and visual dead space.
- (4) The mobile protected firepower of LAVs can be used to add security to resupply convoys and to extract wounded personnel under fire. The LAV's smoke-generation capability can aid this and other small-unit actions.

## 6. LAV Employment Considerations:

- a. **General.** Urban combat is often decentralized and avenues of approach for vehicles canalized. This urban situation calls for fewer armoured vehicles employed over broader areas. Decentralized armour support greatly increases a small infantry unit's combat power. However, dispersed vehicles cannot be easily and quickly concentrated. Their sudden

removal from throughout the combat area will necessitate a tactical pause for reorganization and a change of tactical tempo that could disrupt the ongoing combat operation at a critical time.

- b. **Employment.** LAVs can support infantry during urban combat operations by:
- (1) providing shock action and firepower;
  - (2) isolating objectives with direct fire to prevent enemy withdrawal, reinforcement or counterattack;
  - (3) neutralizing or suppressing enemy positions as infantry closes with and destroys the enemy;
  - (4) obscuring enemy observation using smoke grenade launchers;
  - (5) holding cleared portions of the objective by covering avenues of approach;
  - (6) attacking by fire any other targets designated by the infantry;
  - (7) establishing roadblocks or checkpoints; and
  - (8) suppressing identified sniper positions.
- c. **Vehicle Characteristics.** Fighting in urban areas is centred on prepared positions in houses and buildings. Such positions cover street approaches and are protected by mines, obstacles, and booby traps. Therefore, bridges, overpasses, and buildings must be inspected and cleared of mines before they are used. Reconnaissance parties must ascertain the weight-supporting capacity of roads, bridges, and floors to determine if they can support the weight of LAVs. When uparmoured and fully loaded, the LAV III weighs 20 tonnes.

## LAV Company Tactics (Interim)

7. **Offence.** LAVs provide a very flexible direct fire support asset to dismounted infantry companies conducting operations on urban terrain. The 25 mm cannon and 7.62 mm coax machine-gun provide the company commander powerful combat multipliers during urban combat. As well, the short-range anti-armour weapon (heavy), or SRAAW(H), which may not be practical to carry with the assaulting dismounted infantry, can be quickly brought into action:

a. **Target Engagement.** Streets and alleys are natural firing lanes and killing zones. Because of this, all vehicle traffic is greatly restricted and canalized and subject to ambush and short-range attack. Tanks are at a disadvantage because their main guns cannot be elevated enough to engage targets on the upper floors of tall buildings. The LAV, with +60 to -10 degrees elevation of the 25 mm gun and 7.62 mm coax machine-gun, has a much greater ability to engage targets in urban terrain.

b. **Local Security for the LAVs:**

(1) The need to provide local protection for the LAVs, plus the need to be able to deploy any required support weapons, is likely to require a rifle section for each LAV. Dismounted infantry companies may be task organized with LAV platoons, as opposed to Zulu LAV platoons, when conducting operations in urban terrain. A LAV platoon is capable of providing its own infantry support. Generally, LAVs should not be separated from their infantry. Working as a team, infantrymen (the rifle sections) provide security for the vehicles; the LAVs provide critical fire support for the dismounted company. In more detail:

(a) Two soldiers will normally be in the air sentry hatch covering arcs not being observed by the gunner and crew commander. They are wearing headsets so they can warn the crew commander of any



threats and receive direction or warning from him.

- (b) The remainder of the section will be dismantled and providing local protection.
  - (c) The LAV's radio will usually be operating in non-frequency hopping mode so that the crew commander and dismantled commander can communicate using the section's light assault radio.
- (2) Providing a complete LAV platoon per dismantled rifle company is a major challenge that often will not be obtainable, particularly when the unit has suffered casualties. Options include:
- (a) One rifle company can provide a LAV platoon to each of the other two companies working dismantled. This effectively reduces the battalion to two companies with a reserve of a LAV platoon.
  - (b) One platoon in each company can be tasked as the LAV platoon to support the dismantled platoons. This has the advantages that
    - i. it leaves rifle companies intact; and
    - ii. company commanders can rotate rifle platoons through the LAV role.

## LAV Company Tactics (Interim)

- c. **Movement.** When moving, if the street is large enough, LAVs should stay close to a building on either side of the street. This allows each LAV to cover the opposite side of the street. Regardless whether he is head up or down, the crew commander must remain alert for signals from the infantry. Coordination between mounted and dismounted elements is critical in urban terrain.
  
- d. **Organization.** The company commander will determine how the LAVs will support the dismounted company. Due to the decentralized nature of urban operations, it is likely that the LAVs will be placed in support of individual platoons or sections. Considerations include:
  - (1) Whenever practical, at least two LAVs should be committed as opposed to a single vehicle.
  - (2) The dismounted infantry commander tells the LAV element commander what he needs done. The LAV commander should be allowed to determine how best to provide that support.
  - (3) Given the decentralized nature of the battle, many of the tasks for the LAVs are likely to come directly from sections. The vehicle radios must be in non-frequency hopping mode so they can communicate via the sections' light assault radios.
  
- e. **Tasks.** The most likely tasks that will be given to a LAV platoon supporting a dismounted infantry company in urban combat will be fire support to the dismounted assault element. Direct fire support and other assistance to facilitate the advance of the assault element are provided by the support element. The LAV platoon is well suited to act as the support element for the dismounted infantry company team

during offensive operations. Specific LAV platoon tasks include, but are not limited to:

- (1) suppressing enemy gunners within the objective building(s) and adjacent structures;
- (2) destroying enemy positions within a building;
- (3) providing replacements for the assault element from the LAV's security team;
- (4) providing a mobile reserve for the company;
- (5) providing resupply of ammunition and explosives; and
- (6) evacuating casualties, prisoners and non-combatants.

f. **Direct Fire Support.** The LAV is best used to provide direct fire support to infantry. The LAV should move behind the infantry, when required, to engage targets located by the rifle sections. The dash speed of the LAV enables it to rapidly cross streets, open areas or alleys:

- (1) **Weapons.** The LAV mounted element provides fire with its 25 mm gun and 7.62 mm coax machine-gun for infantry on the opposite side of the street. Of the three natures of 25 mm ammo, frangible will most often be loaded in the primary bin because of its usefulness against fortifications and buildings.
- (2) **Sabot.** The sabot from 25 mm APFSDS-T and FAPDS-T is dangerous out to 100 m from the muzzle in an arc of 200 mils left and right of the barrel. Crew commanders

## LAV Company Tactics (Interim)

must be aware of this when providing close fire support.

- (3) **SRAAW(H)**. SRAAW(H) is more likely to be carried in the LAVs than by the dismounted company. It and any other support weapons being carried can be quickly brought into action by the LAV's own local protection party.
- (4) **Smoke**. The LAV can also provide a smoke screen by using its smoke grenade launchers. This requires careful analysis of wind conditions to ensure that the smoke does not adversely affect friendly units. This is a difficult task since wind currents tend to be erratic between buildings. The smoke can also screen the movements of the LAVs after the infantry moves.

### 8. **Defence:**

- a. **General**. The LAV can provide a valuable combat multiplier in the defence. The following are typical defensive missions that may be given to a LAV platoon:

- (1) providing fire support for infantry and mutual support to other LAV teams;
- (2) destroying enemy armoured vehicles and direct fire artillery pieces;
- (3) destroying or making enemy footholds untenable by fire using the 25 mm gun;
- (4) providing rapid, protected transport;
- (5) reinforcing threatened areas by movement through covered and concealed routes to new firing positions;

- (6) providing mutual support to other anti-armour fires;
  - (7) providing a mobile reserve and counterattack force;
  - (8) providing resupply of ammunition and other supplies; and
  - (9) evacuating casualties, prisoners, and non-combatants.
- b. **Company Fire Plan.** The LAVs will be integrated into the company's defensive fire plan. The 25 mm gun and 7.62 mm coax machine-gun fields of fire should cover streets and open areas. Once placed in position, LAVs should not be moved for logistical or administrative functions—such movement draws attention. Other vehicles should accomplish these functions, when possible:
- (1) **Positioning of Vehicles and Weapons.** Once the company commander gives the LAV platoon commander his mission, the platoon commander will position his LAVs and supporting infantry. For the coax to have grazing fire, the LAV must be in a hull-down position. LAVs are assigned primary, secondary and alternate positions.
  - (2) **Engagement Ranges.** The anti-armour capability of the LAV is degraded by short ranges and must be supplemented by SRAAW(H). Anti-armour positions should be placed where they can support the LAV but must not attract enemy attention to the LAV location.
  - (3) **Integration of Fire.** All of the LAV's crew-served weapons are integrated with the rest of the company team's weapons and assets. The positions are recorded on a

LAV Company Tactics (Interim)

company sector sketch and forwarded to the battalion.

**APPENDIX 1**  
**ENGAGEMENT HEIGHTS—TANKS AND LAVS**

1. Urban operations frequently impose very short ranges on weapon systems. For turret-mounted systems, this can have major limitations on the maximum height of target that can be engaged successfully. The maximum heights for both the LAV and Leopard C2, for a given range, are shown below (for the purpose of this appendix, the average height of a building storey is estimated at 3.5 m):

Distance to Tgt	Max Height of Target—LAV		Max Height of Target—Tank	
	Metres	Storeys	Metres	Storeys
5	11	3	4	1
10	19	6	6	2
20	37	10	9	3
30	54	15	13	4
40	71	20	17	5
50	89	25	20	6
60	106	30	24	7
70	123	35	27	8
80	141	40	31	9
90	158	45	35	10
100	175	50	38	11
150	262	75	57	16
200	348	100	75	21





**ANNEX D**  
**NINE RULES TO HELP YOU STAY ALIVE**  
**WITH THE LAV III**

1. Don't move close to, and especially don't stop close to destroyed friendly vehicles. That spot is obviously in the enemy's kill zone, and he has a weapon system that is ranged in and watching that area.
2. If you would use a landmark, an object, a crossroads, etc. as a direct fire target reference point or as an indirect defensive fire reference point, so would the enemy. Stay away from it and, in particular, don't use it as a rally point.
3. Look before you move. Take the time to search the ground before the next bound.
4. When searching the ground, if possible, use more than one type of sensor—visual and TI by day and TI and II by night. They are complementary and increase the chance of your seeing the enemy before he sees you.
5. Jockey after engagements. As soon as you fire, you draw attention to yourself.
6. Don't crest unless you absolutely have to. If possible, try to position yourself so there is something behind you—vegetation, another hill, etc.—so you are not silhouetted. If you must crest, do the actual cresting as quickly as possible and, if more than one vehicle is cresting, simultaneously. While neither is good, you are better off on the forward slope than the crest.
7. Listen to your driver. He knows better than you what terrain the LAV will and will not get through and when you must slow down and lower the tire pressure.
8. Remember that, as infantry, you have the ability to dismount and investigate. A 17-tonne vehicle is easier to spot than a motivated infantryman.
9. A 4,000-metre line of sight allows the enemy to shoot you 2,000 m before you can shoot him.



## CHAPTER 2 OFFENCE

### GENERAL

1. **Combined Arms Team.** The light armoured vehicle (LAV) company normally conducts offensive operations as part of a combat team. This combined arms grouping is always desirable and is essential when the defending enemy has tanks. Details of LAV company, tank squadron, and engineer troop co-operation in the offence are in B-GL 321-006/FP-001 *Combat Team Operations*, published by the Tactics School.
2. **LAV Tasks.** Light armoured vehicles are not normally sent to a Zulu harbour on the fight through the objective. The LAV can be used to:
  - a. provide intimate support to dismounted infantry at the section, platoon or company level;

#### NOTE

Intimate support does not refer to the proximity of the LAVs to the supported infantry. It is a measure of the responsiveness of the supporting unit and the effectiveness of the fire. For the LAVs to provide intimate support, they must be able to communicate directly with the supported organization and must be able to respond quickly with effective fire.

- b. establish a supplemental fire base or to re-enforce an existing one;
- c. cut off;
- d. provide flank security, if teamed with heavy anti-armour in the face of a tank threat; or
- e. exploitation.

3. **Attack by Fire.** It may not always be necessary to close with the enemy and fight through the objective to effectively destroy him. Ideally, the company (combat team) will place the enemy in a situation where he must either surrender or face total destruction from direct fire cannon, machine-gun (MG) and missile fire, and indirect assets. As a minimum, to be considered successful, the attack by fire must result in the destruction of the enemy's major weapons and ability to manoeuvre so that he is unable to interfere with friendly operations. The remaining enemy can then be dealt with by follow-on forces. Considerations for the attack by fire include:

- a. **Weight of Fire.** More is better than less. While taking into account the need to maintain security and flexibility, all direct and indirect assets able to bring effective fire to bear on the enemy should be used.
- b. **Simultaneous Commitment of Forces.** All forces engaged in the attack by fire should be committed to the battle as simultaneously as possible. Ideally, the entire force committed to the task should crest simultaneously with the kill zone having been previously divided between them by the commander. This provides the heaviest possible initial strike on the enemy with multiple friendly weapon systems engaging each of the key enemy systems. This helps to ensure that the most dangerous enemy systems are destroyed before they have an opportunity to return fire. Committing friendly forces piecemeal can result in their being destroyed piecemeal.
- c. **Range.** Forces should be committed within their effective range but beyond the effective range of as many of the enemy weapon systems as possible. For the LAV III, the effective range is generally between 800 and 1,800 m.
- d. **Infantry.** The commander must decide what he will do with his infantry during the attack by fire, in particular, with those whose weapons cannot be brought to bear on the objective. Considerations include:

- (1) **Remaining Mounted.** If the commander keeps his infantry mounted, they will be immediately available for follow-on tasks and have good protection against the indirect fire that the enemy will almost certainly call in. When a LAV is destroyed, however, this will result in a larger number of casualties than if the infantry had not been mounted.
  - (2) **Local Security.** The infantry could be tasked to provide local security. In this option, casualties incurred when LAVs are destroyed will be reduced and the infantry will be close enough to the LAVs to be quickly remounted for follow-on tasks. The infantry, however, will be extremely vulnerable to the enemy's indirect fire and can be expected to suffer significant casualties if it is effective.
  - (3) **Left in Another Location.** The infantry could be left in another location before the attack by fire begins. This option would effectively be a Zulu harbour for personnel instead of vehicles. Depending on distances and terrain, this option may impose significant additional delays on the company before it can carry out follow-on tasks.
- e. **Enemy Artillery.** Enemy artillery and other cluster-type munitions pose a major threat. To minimize the threat, the commander should:
- (1) spread his forces out as much as practicable consistent with concentrating their fire on the objective; and
  - (2) move as soon as possible once the task is finished.

- f. **Fighting Through the Objective.** There is always the possibility that the attack by fire will not be wholly successful. The commander must be prepared to commit forces to close with the enemy and fight through the objective if the attack by fire does not achieve its aims.

4. **Attacking Mounted.** The LAV III armoured personnel carrier (APC) is not designed for mounted attacks, that is, conducting the fight through the objective with the infantry remaining mounted. It has no firing ports, firing from the cargo hatches restricts the turret from being used over the rear third of the vehicle, and the vehicle is vulnerable to all hand held anti-armour weapons. The large amount of firepower carried by the rifle section can only be brought to bear on the enemy when the section dismounts. Attacking mounted should only be considered when:

- a. the enemy does not have a credible anti-armour defence, including simple, short- range systems; and
- b. it is not intended to clear the enemy from his positions at this time (this would have to be the task of some other follow-on organization) but simply to suppress him long enough to allow the force to press on through.

5. **Dismount Options.** The dismount options of short, on and beyond the objective remain valid. Considerations for each are shown below:

- a. **Short.** The commander dismounts short of the objective when terrain makes proceeding mounted to the objective impossible or when the enemy's anti-armour defence is strong. The commander must weigh the casualties he believes he will suffer from the enemy's indirect and small arms fire, while closing dismounted to the objective, with the casualties he believes he would suffer from bringing loaded LAVs within range of the enemy's short-range anti-armour weapons (SRAAWs).

- b. **On.** In this option, the commander uses the LAV's armour to protect his soldiers from the enemy's small arms and indirect fire in their move to the objective. In doing this, however, he brings loaded LAVs within range of all of the enemy's anti-armour weapons. For this option to be viable, the commander must have suppressed the enemy's anti-armour defences, including simple, short-range systems.

#### NOTE

If the dismount point is closer than 15 m from the forward enemy trenches, then the gunner and crew commander cannot bring fire to bear upon them.

- c. **Beyond.** By dismounting beyond the objective, the enemy is attacked by an unexpected direction. Specific considerations with this option include:
- (1) **Suppression of Enemy Anti-armour Defences.** To get beyond the objective requires that the LAVs, with their infantry, travel over the objective. Enemy anti-armour defences must be suppressed to an even greater extent than that required for dismounting on the objective.
  - (2) **Enemy Depth Positions.** If the commander does not have accurate information as to what is beyond the enemy position, this option may simply place him in the kill zone of the depth position.

## ATTACKING WITH TANKS

6. **General.** As stated earlier, attacking with tanks is the rule. It is not the intent to repeat the information provided in B-GL 321-006/FP-001, *Combat Team Operations*, but to amplify those aspects of particular importance to the infantry.

## LAV Company Tactics (Interim)

7. **Action on Contact.** On contact, the company commander moves to a position of observation to see the situation and confer with the squadron commander. If he can do so, the company commander lazes key points on the objective to get accurate grids. The LAV captain ensures the company is out of contact and able to move to an RV as soon as ordered. The company 2IC, who is travelling with the A1 echelon (but not commanding it), sends the appropriate reports and returns to battalion and acts as the company's command post.

8. **Action at the Rendezvous.** Once the combat team commander has chosen the RV, the company moves to it. Artillery and air launched cluster munitions pose a major threat to a stationary armoured / mechanized organization. Vehicles in the RV spread out as much as possible consistent with the need to pass information and maintain local security and to minimize the artillery/ cluster munitions threat. The following actions should then take place:

- a. Once orders have been given, all key grids are input into the TacNav system. If there is time for only one grid, it should be that of the objective.
- b. Any change around between commanders in the turret and in the back must be done out of contact. Commanders who are dismounting on the objective move to the back of the vehicles as described in figure 1-10. An exception to this is the company commander. If he chooses to dismount on the objective, he is likely to stay in the turret until the actual moment of dismount.
- c. If it is intended to have the LAVs provide intimate support to their individual sections, the company then switches the A sets for its internal net to fixed frequency so they can speak to the dismounted element using the light assault radio.

9. **Move to the Attack Position:**

- a. The LAVs follow the tanks to the attack position. Once in the attack position, if not before, all LAVs go hatches down. If there are no obstacles to be breached, the LAVs assume their assault formations

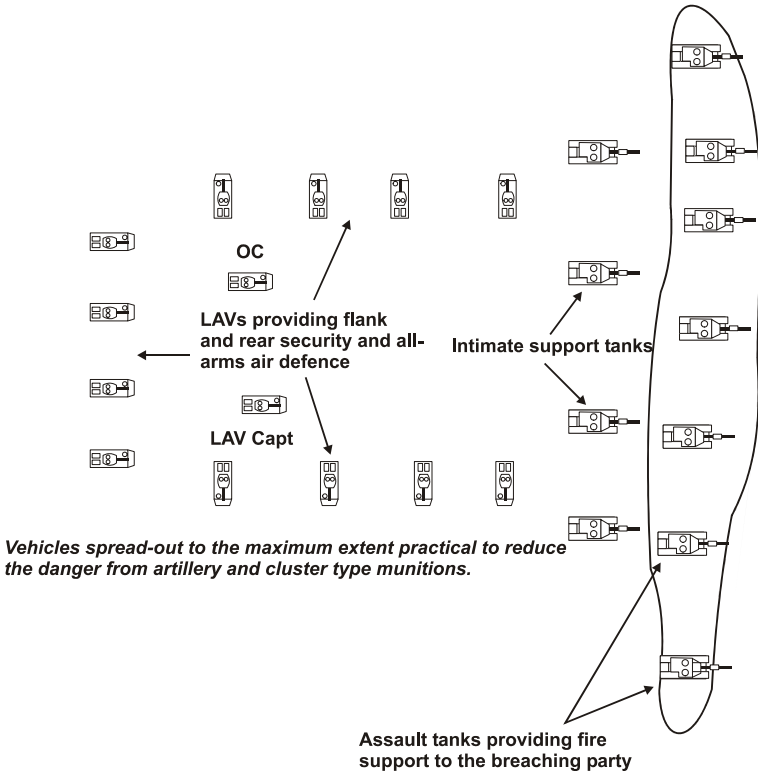


behind the intimate support tanks at the attack position. The assault formation and the number of platoons initially committed depends on the plan.

- b. Regardless as to the assault formation chosen, adopting the assault formation requires the force to close in. If it remains stationary for any length of time, it provides an ideal artillery/ cluster munitions target. The commander should aim to roll through the attack position without stopping.

10. **Obstacle Breaching.** If there are obstacles to be breached, the LAVs do not assume their assault formations until through the obstacle. Obstacles are normally breached by a combination of engineers, plough and roller tanks IAW breaching drills outlined in B-GL-321-006/FP-001 *Combat Team Operations*. While this is happening, the LAVs remain spread out in the attack position to the maximum extent practicable. While the assault tanks are providing fire support for the breaching, the LAVs provide:

- a. provide flank and rear security for the attack position; and
- b. provide all-arms air defence (AAAD).

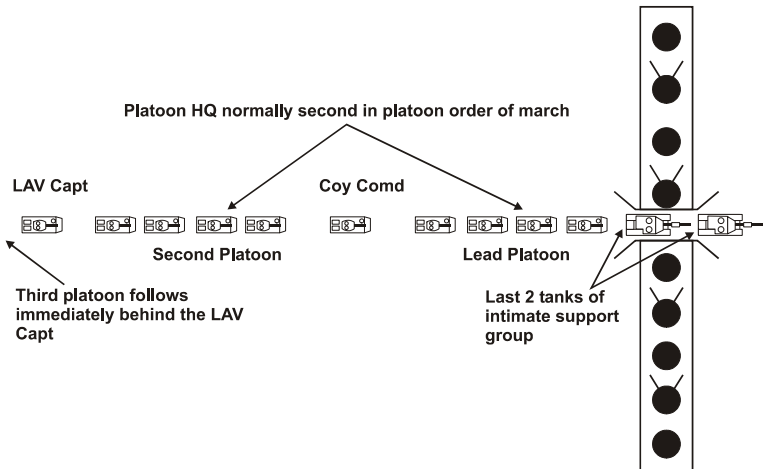


**Figure 2-1: Action in the Attack Position During the Breaching**

11. **Move Through the Obstacle.** On order, the LAVs move through the obstacle behind the intimate support tanks. The order of the LAVs depends on whether one or two breaches are used:

- a. **One Breach.** The order for the LAVs behind the intimate support tanks is:
  - (1) first assault platoon (platoon HQ is usually the second vehicle);
  - (2) company commander;
  - (3) second assault platoon (platoon HQ is usually the second vehicle);
  - (4) LAV captain; and

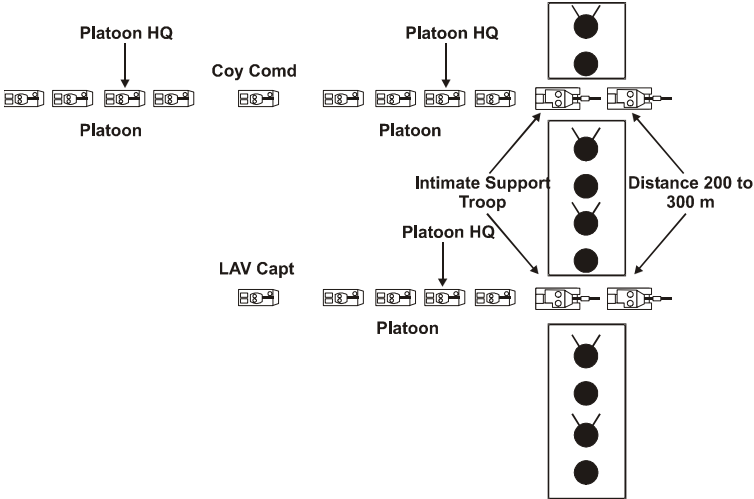
- (5) third platoon (platoon HQ is usually the second vehicle).



**Figure 2-2: Move Through the Obstacle—One Breach**

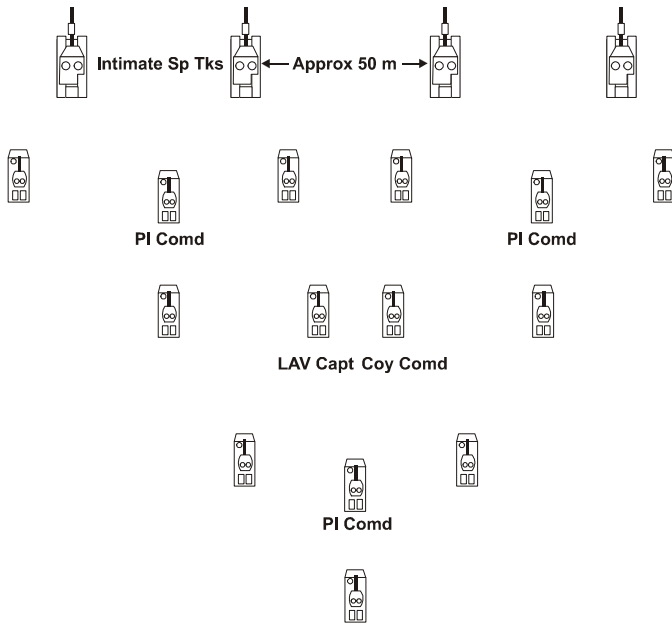
- b. **Two Breaches.** The normal distance between breaches in a combat team assault is 200 to 300 m. If two breaches are used, the order for the LAVs behind the intimate support tanks for each of the breaches is:
- (1) lead assault platoon;
  - (2) company commander on the side where he believes he can most influence the battle and LAV captain on the other side; and
  - (3) third platoon to whichever side ordered.

# LAV Company Tactics (Interim)



**Figure 2-3: Move Through the Obstacle—Two Breaches**

12. **Assault Formations.** If the combat team has not been able to move directly from the attack position to the dismount point in its assault formation, it must assume that formation immediately after moving through the obstacle. The example given below is a template that can and will be modified depending on the circumstances.



**Figure 2-4: Sample Assault Formation**

13. **Move to the Dismount Point.** The LAVs follow behind the intimate support tanks to the dismount point at best possible speed. If it is good going, the option of having the LAVs break cover after the tanks have covered a portion of the distance to the objective should be considered. With their higher speed, the LAVs can catch up to the tanks by the dismount point while being exposed to enemy fire for a shorter period. This option must be tempered with the knowledge that LAVs moving at maximum speed cross-country cannot bring effective fire to bear on the enemy:

- a. **Arcs of Responsibility.** Lead LAVs engage targets of opportunity to their front. Depth LAVs cover the flanks. Care must be taken not to strike friendly tanks as the 25 mm armour-piercing, fin stabilized, discarding sabot-tracer (APFSDS-T) and frangible, armour piercing, discarding sabot-tracer (FAPDS-T) can penetrate the rear of the hull and disable the tank's engine.

## LAV Company Tactics (Interim)

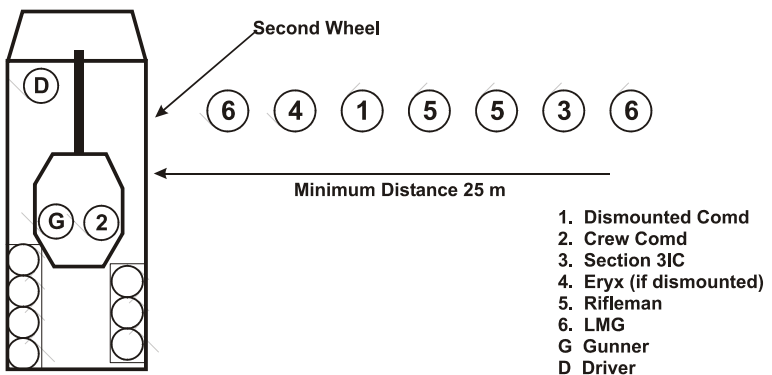
- b. **Navigation.** If there is a single company dismount point, the company commander is responsible to ensure that the intimate support tanks are headed towards it. If there are separate platoon dismount points, the intimate support tanks are usually divided between the two lead platoons. In this case, it is the platoon commanders' responsibility to check the tanks' navigation. In either case, the TacNav in Steer To mode is used to assist the commanders.

14. **Action at Dismount Point.** The dismount point should not be closer than 15 m from the nearest trenches as this is the closest the crew of the LAV can bring the turret to bear. If there is one dismount point, the company commander's vehicle gives the order to dismount. If there are separate platoon dismount points, the platoon commanders' vehicles order the dismount. Regardless, on the order to dismount:

- a. Intimate support tanks stop approximately 20 m in front of the enemy trenches and the LAVs close up with the tanks and stop. Both bring the maximum possible fire to bear on any enemy positions. If the enemy location is well fortified and there are specific break in points, then those areas in particular are suppressed.
- b. At the dismount, smoke may be popped by the LAVs. At this time, the only smoke grenades available for the LAV are hexachloroethane (HC). Considerations are:
  - (1) A volley of eight HC smoke grenades takes approximately 30 seconds before the smoke has built to the point where it is effective.
  - (2) When fired, the 76 mm smoke grenades go approximately 40 m. If the soldiers are dismounting on the objective, the smoke screen is likely to be behind the forward trenches. This may be desirable, however, in that the dismounting troops will be able

to see their objectives while being screened from fire from depth positions.

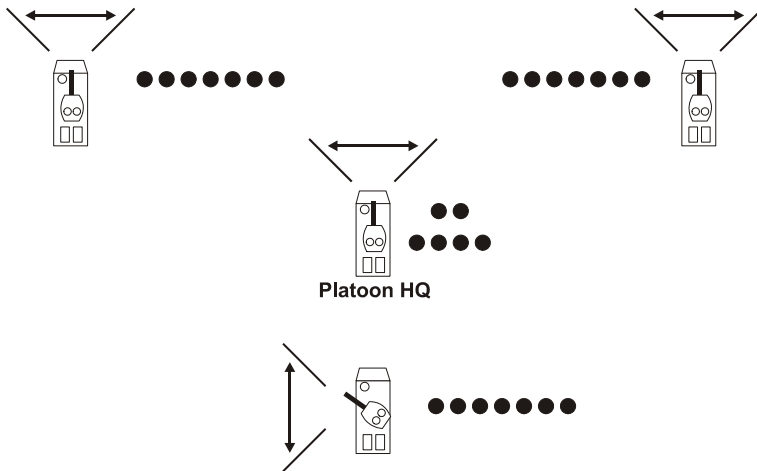
- (3) The LAVs will be able to see and shoot effectively through the smoke using thermal sights.
- c. The crew commander opens his hatch so he can operate head out.
- d. Forward sections dismount to the inside, left-hand sections to the right of their vehicles and right-hand sections to the left of their vehicles. Rear section and platoon HQs usually dismount to the right side, where they can be seen by the crew commander. Once the last man has cleared the back of the vehicle, the section signals the vehicle with a thumbs up (to the crew commander for those on the right side of their vehicles and to the gunner for those on the left side).



**Figure 2-5: Left Section Vehicle—Dismounting to the Right**

- e. Once the section has given the thumbs up, the Zulu LAVs move to their locations in preparation for the fight through the objective.
- f. Within the forward platoons, all sections and the platoon HQ normally dismount.

## LAV Company Tactics (Interim)



**Figure 2-6: Left Front Platoon Dismounting**

15. **Fighting Through the Objective.** Within the assault force, intimate support tanks and Zulu LAVs work to maximize their combined effective fire on the enemy and minimize each individual element's weaknesses. Assuming that the objective is passable to vehicles, the intimate support tanks will normally lead the assault over the objective. The role and tasks of the intimate support tanks are covered in B-GL 321-006/FP-001 *Combat Team Operations*. In summary, however, the intimate support tanks use their main gun to destroy hard targets on the objective and their shock action and coax MGs to destroy and/or suppress enemy dug-in infantry. There are several options, however, for how the dismounted infantry and Zulu LAVs can co-operate during the fight through the objective.

a. **General:**

(1) **Command:**

- (a) **Single Company Objective.** If there is a single company objective where the fire of the Zulu LAVs can be co-ordinated, then the Zulu LAVs are usually controlled by the LAV Capt on behalf of the company commander. The company commander orders the LAV Capt



and the intimate support troop leader to resume moving forward once the lead platoons have dismounted.

- (b) **Platoon Objectives.** If there are separate platoon objectives where the fire of the entire Zulu company cannot be effectively controlled from one point, then the Zulu LAVs are usually controlled by the LAV Sgt on behalf of the platoon commander.
- (2) **Targets.** The Zulu LAVs use their 25 mm cannons to destroy any hard targets missed by the intimate support tanks and their coax MGs to destroy and/or suppress enemy dug-in infantry to their front.
- (3) **Arcs.** In the absence of specific orders to concentrate or co-ordinate fire, each Zulu LAV covers a 60° arc directly to its front.
- (4) **Company Commander's LAV.** If the company commander dismounts, his LAV teams with the LAV Captain's vehicle. If the company commander does not dismount, his vehicle moves independently.
- (5) **Depth Platoon:**
  - (a) **Mounted Reserve.** If the depth platoon is to be kept as a mounted reserve, it should be kept in a covered location until tasked. Given the speed capability of the LAV, it does not have to be right up with the assaulting troops.
  - (b) **Depth on the Assault.** If the depth platoon is to be used during

LAV Company Tactics (Interim)

the fight through as depth, then it should be dismounted to bring all the platoon weapons into play and to minimize casualties if a vehicle is destroyed.

(c) The depth platoon Zulu LAVs can be given other tasks such as:

- i. moving forward to provide additional fire support for the dismounted company;
- ii. flank guard (if teamed with adequate heavy anti-armour resources) or screen (if operating alone);
- iii. cut-off;
- iv. establishing a supplemental fire base; or
- v. exploitation with the tanks.

b. **Zulu LAVs Behind Dismounted Infantry.** In this option, the dismounted infantry moves behind the intimate support tanks followed by the Zulu LAVs.

(1) **Advantages:**

- (a) **Simplicity.** There is minimal reorganization and movement of vehicles on dismount. Once the dismounted element is ready, it simply moves forward behind the intimate support tanks. The Zulu LAVs then follow.

- (b) **Command Structures.** All command structures are available. LAVs can be controlled at the section, platoon or company level.
  - (c) **Protection of LAVs.** With the Zulu LAVs at the rear, they are somewhat more difficult targets for simple hand-held anti-armour weapons on the position. Additionally, the LAVs can manoeuvre, supporting each other at the team, platoon or company level.
  - (d) **Flexibility.** The LAVs are all together and not intertwined with the dismounted element. It is likely to be easier to commit Zulu LAVs to meet an unexpected threat if they are at the rear than in some other locations.
- (2) **Disadvantages.** The chief disadvantage of the Zulu LAVs being behind the dismounted infantry is a lack of fire support from the Zulu LAVs. Having the dismounted infantry in front of them is likely to screen the Zulu LAVs for much if not all of the time. Under those circumstances, Zulu LAVs may simply become targets without being able to add anything to the battle.

LAV Company Tactics (Interim)

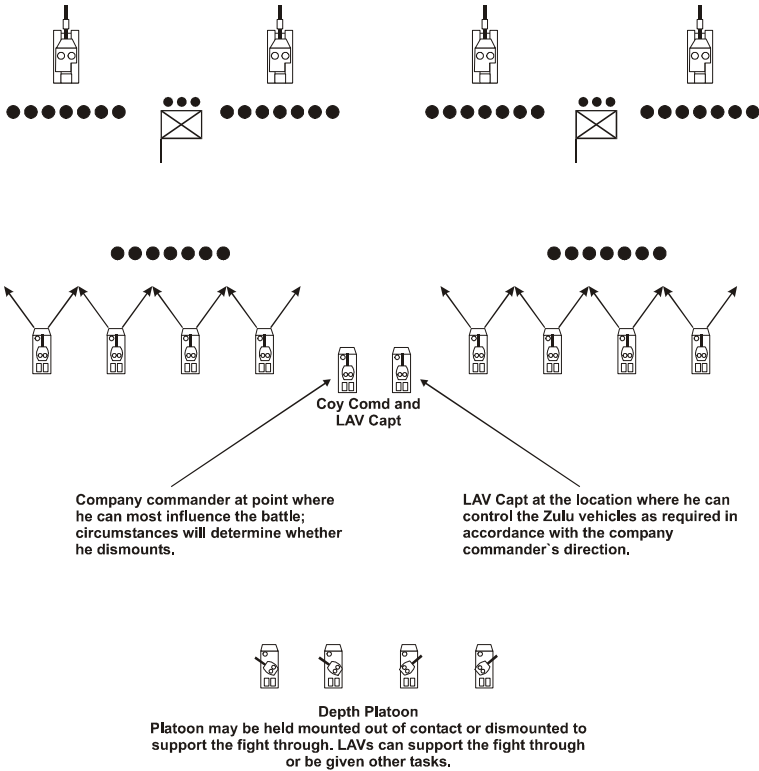


Figure 2-7: Zulu LAVs Behind Dismounted Infantry

c. **Zulu LAVs in Line with the Dismounted Infantry.** In this option, the Zulu LAVs move into line with the dismounted infantry, each beside its own element:

- (1) **Advantages:**
  - (a) **Fire Support.** Fewer LAVs are screened by friendly soldiers than with the previous method. This allows more effective fire to be brought to bear by the LAVs.
  - (b) **Frontage.** The addition of the LAVs to the frontage of the

platoon allows the platoon to cover a larger area.

- (2) **Disadvantages:**
- (a) **Command and Control:**
- i. The vehicles amongst the dismounted troops may make it difficult for the platoon commander to see all his soldiers.
  - ii. Because the vehicles are amongst the soldiers, they are tied to their sections. Command of the Zulu LAVs at levels above section is not likely to be practical.
- (b) **Vulnerability.** With the LAVs amongst the troops, there is little scope for the LAVs being able to manoeuvre to support one another at any level.
- (c) **Inflexibility.** The LAVs are too tightly entwined with the dismounted soldiers to allow for quick regrouping to meet an unexpected threat.
- (d) **Gaps.** There are likely to be gaps in the assaulting element, in particular between the two lead platoons, where there are no dismounted infantry. This may allow enemy positions to be bypassed accidentally.

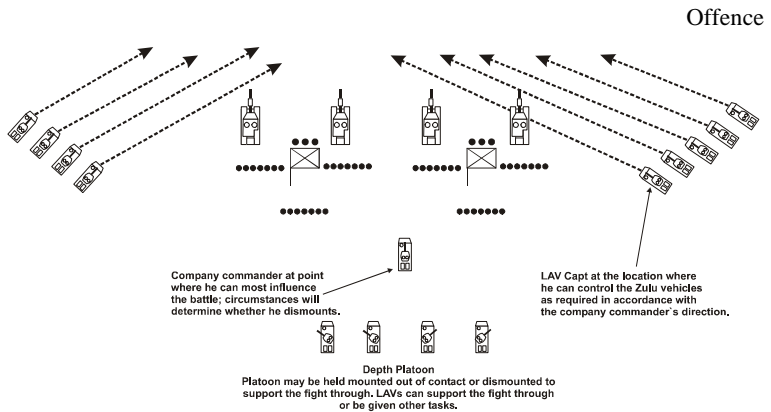


- (b) **Protection.** The LAVs may be able to establish their supplemental fire bases outside of simple, hand-held anti-armour range. They should have hull-down and, ideally, turret-down positions. As well, flank positions should allow the Zulu LAVs to operate in platoon-sized groups as a minimum. These factors should improve LAV survivability.
  - (c) **Flexibility.** Because the Zulu LAVs are grouped at least at platoon level, and because they are not intertwined with the dismounted infantry, they can be relatively easily reoriented and/or regrouped to deal with an unexpected threat.
  - (d) **Objective Impassable to LAVs.** If the objective is impassable to LAVs, the positioning of Zulu LAVs on the flank(s) may be the only option that allows for the contribution of the LAV in the close battle.
- (2) **Disadvantages:**
- (a) **Time.** It may take several minutes after the dismount for the Zulu LAVs to move to a flank(s) and establish the supplemental fire base(s). During this time, they are unlikely to be able to contribute to the fight.
  - (b) **Vulnerability.** During the move to the flank(s), the Zulu LAVs are likely to be very vulnerable to

anti-armour fire. In particular, if the Zulu LAVs must expose their flanks to the enemy to get to the supplemental fire base(s), they may suffer significant casualties.

- (c) **Command and Control.** Not all command and control structures are appropriate. Distances from the supplemental fire base(s) to the objective are likely to make intimate support at the section level impractical. Zulu LAVs OPCOM to the platoon commander and OPCON to the LAV Sgt is the lowest level of command and control that could be exercised effectively. In cases where suitable fire positions exist on one flank only, Zulu LAVs OPCOM to the company commander and OPCON to the LAV Capt may be the only command and control option.
- (d) **Dead Ground.** There are likely to be areas of dead ground on the objective that cannot be suppressed from the supplemental fire base(s).





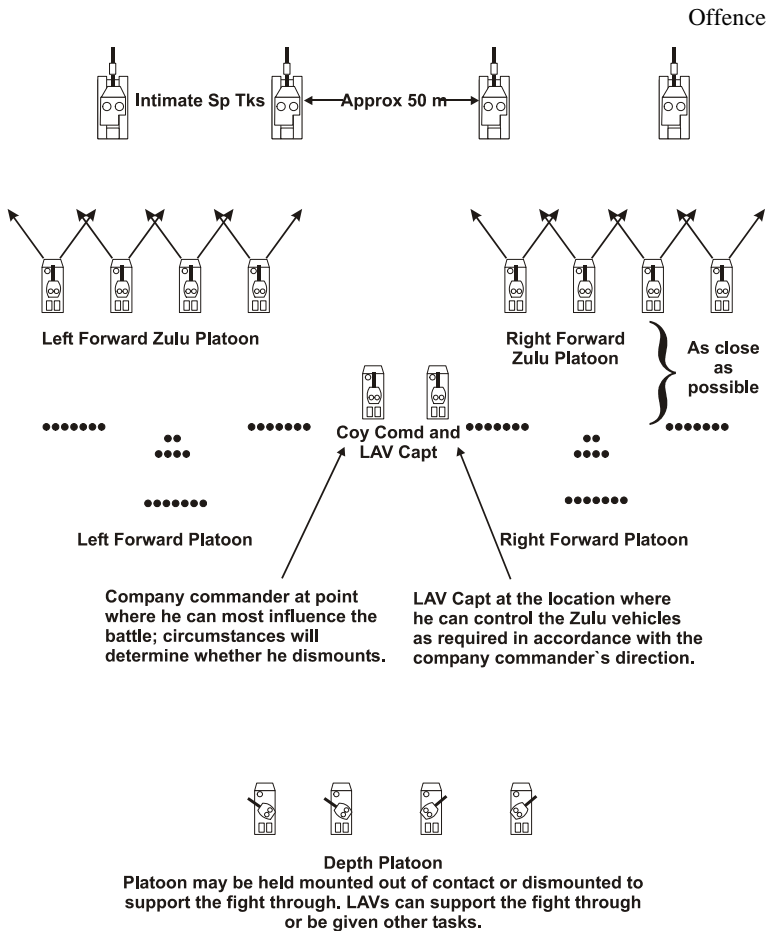
**Figure 2-9: Zulu LAVs to the Flank(s)**

- e. **Zulu LAVs Between the Intimate Support Tanks and the Dismounted Infantry.** In this option, the Zulu LAVs move forward of the soldiers after the dismount and follow immediately behind the intimate support tanks. The dismounted soldiers follow behind the Zulu LAVs. The tanks and Zulu LAVs use their stabilized armaments to destroy/suppress targets to the front. The dismounted soldiers follow closely enough behind to destroy any remaining targets before they are able to shoot the intimate support tanks and Zulu LAVs from the side or rear:

- (1) **Advantages:**
- (a) **Fire Support.** This arrangement allows close to the maximum effective fire to be brought on the enemy. The tanks can use all of their armament without restriction. The LAVs can use their coax without restriction but must exercise some caution with the 25 mm cannon as the back of the Leopard can be penetrated by it. The dismounted element can use all of their small arms without restriction.

## LAV Company Tactics (Interim)

- (b) **Shock Action.** There is the maximum shock action on the enemy.
- (2) **Disadvantages:**
- (a) **Co-ordination.** It is critical that the dismounted infantry remain closed up behind the Zulu LAVs. If they fall behind, then enemy anti-armour gunners who were not destroyed will be able to shoot the Zulu LAVs and intimate support tanks from the rear as they pass by.
  - (b) **Restrictions on Zulu LAV Movement.** Having the dismounted infantry follow behind the Zulu LAVs restricts the Zulu LAVs' ability to manoeuvre, as they cannot reverse without the chance of running over friendly troops.
  - (c) **Regrouping.** With the Zulu LAVs between the intimate support tanks and the dismounted infantry, it may be difficult to pull them out to deal with an unexpected threat.



**Figure 2-10: Zulu LAVs Between the Intimate Support Tanks and the Dismounted Infantry**

**16. Reorganization:**

- a. On reorganization, the LAVs stop in the best available local cover, while the dismounted infantry conduct their normal reorganization. Once the dismounted troops have assumed their reorganization positions, section guides guide in their respective LAVs.
- b. Once the LAVs have linked up with their sections, they resupply ammunition and dismount support

## LAV Company Tactics (Interim)

weapons as required. Once the ammunition resupply and dismounting of support weapons is complete, the LAVs are available for other tasks, depending on the mission and the state of the company. These include:

- (1) assisting in casualty evacuation;
- (2) re-mounting the infantry;
- (3) moving forward to reinforce the tanks;
- (4) providing a flank screen, if operating alone, or guard, if reinforced with adequate heavy anti-armour assets; and
- (5) taking up a hasty defensive posture.

## ATTACKING WITHOUT TANKS

17. **General.** Without adequate anti-armour of its own, the LAV company does not conduct mechanized offensive operations against an enemy with tanks. There are other circumstances, however, when the LAV company conducts mechanized offensive operations. These circumstances can include:

- a. destroying enemy positions bypassed by lead combat teams; and
- b. rear area security operations against parachute or helicopter inserted troops.

18. **Sequence of Events.** Most elements of the attack without tanks follow the same general sequence and method as the attack with tanks. Key differences are shown below.

19. **Enemy Strength.** When attacking without tanks, the LAV company must form its own fire base. This reduces the amount of combat power that can be used to close with the enemy. Additionally, the mine ploughs and rollers on the tanks provide the chief means of breaching minefields. An isolated rifle platoon with its APCs, but

without serious obstacles, is the limit that the unsupported LAV company can reasonably expect to attack.

20. **Action on Contact:**

- a. A BMP-2 equipped enemy will seek to bring the LAV company under missile fire beyond the effective range of the LAV's cannon. Under these circumstances, the LAVs must move as quickly as possible to cover and, from there, close to within the effective range of the 25 mm cannon using cover. If caught in the open away from any cover, the commander must make an immediate decision—either to move forward at maximum possible speed until within the effective range of the 25 mm cannon or to withdraw at maximum possible speed out of the effective range of the BMP-2 missile (5 km for the AT-5).
- b. The company commander normally moves to where he can see the objective. Before he moves, however:
  - (1) the lead platoon(s) should be allowed to develop the situation—how many, how big, what weapons, where;
  - (2) the lead platoon(s) should recommend a location and a route that will allow the company commander to see what he needs to see without becoming a target of opportunity for the enemy; and
  - (3) the company commander confirms over the net his route so that he does not accidentally become a target for friendly forces.

21. **Winning the Firefight.** The key elements in winning the firefight are the destruction of the enemy APCs and the suppression/destruction of his anti-armour weapons. The LAVs

## LAV Company Tactics (Interim)

should attempt to win the firefight at ranges between 800 and 1,800 m. At those ranges:

- a. the uparmoured LAV is protected, frontally, against BMP-2 30 mm AP (armour piercing) rounds;
- b. the 25 mm cannon's combination of speed of engagement and accuracy is superior to the BMP-2 missile; and
- c. the LAV is beyond the range of non-guided, ground mounted anti-armour weapons.

22. As many LAVs as practicable should be committed to winning the firefight, and they should be committed to that action as simultaneously as possible. Initial forces should piquet without engaging unless the enemy attempts to manoeuvre. Having two or three LAV platoons engage the enemy simultaneously greatly increases the chances that all the enemy APCs and anti-tank guided missiles (ATGMs) will be destroyed or suppressed before the enemy has had a chance to guide a missile onto a LAV. Once the firefight has been decisively won, some LAVs can be re-tasked for the assault.

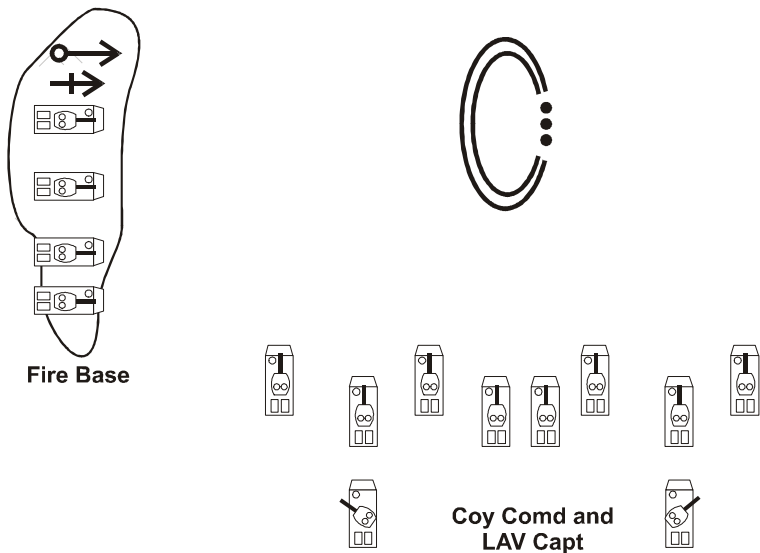
23. **Secondary Fire Base.** If the initial LAV fire base is beyond 7.62 mm coax suppression range, it should move forward to the 800 to 1,200 m range once the APCs have been destroyed. This allows the maximum MG fire to be brought to bear on the objective.

24. **Enemy Artillery.** As was described earlier in this chapter, enemy artillery and cluster-type munitions form a major threat. The company, particularly when it is stationary, must spread out as much as possible, consistent with accomplishing its tasks, and move as soon as possible after the task is completed.

25. **Quick Attack.** In a quick attack, once the firefight has been won, the fire base normally is made up of an infantry platoon complete, usually one of those that first came under fire. While this is likely to result in riflemen who are unable to engage the enemy, it is usually not possible to conduct a major regrouping within the company once in contact with the enemy. Other considerations are as follows:

- a. If practical, and if the fire base is close enough to the objective for their weapons to effectively engage, the quick attack is reinforced by the weapons detachments from the company HQ and the other two platoons.
- b. The fire base commander must weigh the danger of leaving the troops in the LAVs or dismounting them. If they remain in the LAVs, they become additional casualties if a LAV is destroyed. If they dismount from the LAVs, they become vulnerable to artillery.

**Figure 2-11: LAV Company Quick Attack**



26. **Deliberate Attack.** In a deliberate attack, the company could be regrouped to maximize the firepower of the fire base and the number of riflemen available to close with the enemy. To accomplish this:

- a. each platoon detaches to the fire base one vehicle, its weapons detachment and enough additional soldiers to man all the platoon support weapons;
- b. the company weapons detachment is detached to the fire base;

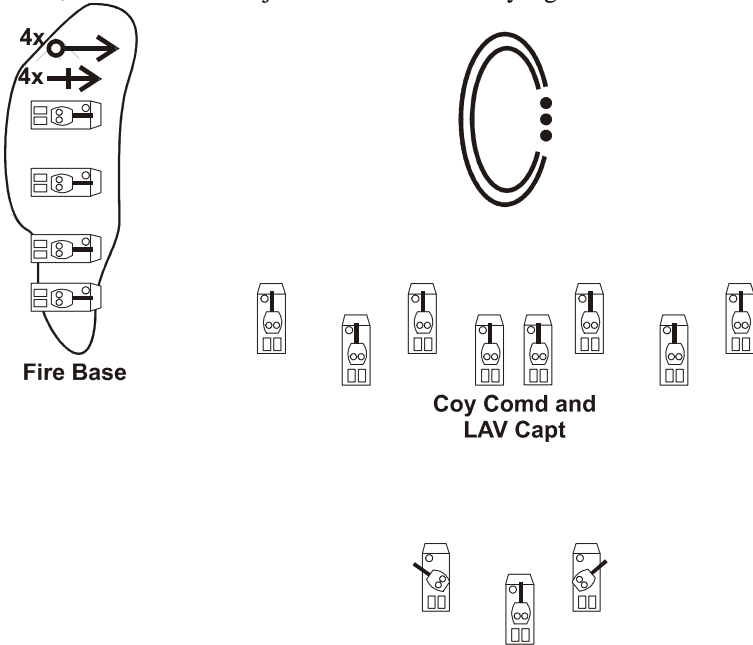
LAV Company Tactics (Interim)

- c. the company 2IC commands the fire base; and
- d. the remaining platoon personnel are redistributed among their three remaining vehicles.

27. The result is a fire base with four LAVs, four SF general purpose machine-guns (GPMGs) and four 60 mm mortars and an assault force with 11 LAVs and nine rifle sections.

**Figure 2-12: LAV Company Deliberate Attack**

28. **Fighting Through the Objective.** The Zulu LAVs, not tanks, lead across the objective. This is the only significant difference



between fighting through the objective with tanks and without tanks.

29. **Reorganization.** There are no significant differences between the reorganization with and without tanks.

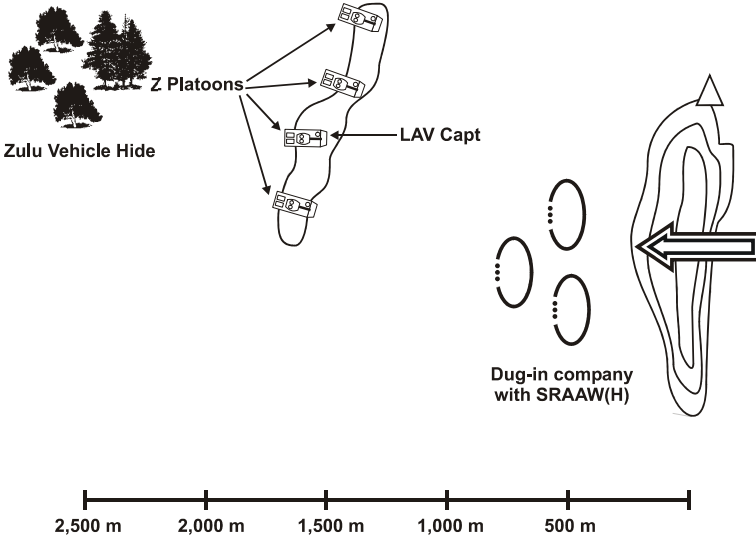


## CHAPTER 3 DEFENCE

### AREA DEFENCE

1. **General.** The light armoured vehicle (LAV) company area defence consists of two main elements—the dismounted company with its weapons and the Zulu LAVs. The two elements are each sited to their maximum effective ranges and so that they do not receive return fire from beyond their maximum effective ranges. The general concept is shown below in figure 3-1.
2. **Division of Targets.** Short-range anti-armour weapons (heavy) (SRAAW(H)) concentrate on tanks. LAVs concentrate on killing light armour, in particular armoured personnel carriers (APCs), before they dismount their troops.
3. **Simultaneous Open Fire.** Short-range anti-armour weapons (heavy) and LAVs are sited so that they can open fire simultaneously. By opening fire simultaneously, the coy:
  - a. retains surprise longer;
  - b. kills the maximum number of enemy vehicles in the first exchange, leaving fewer to return fire; and
  - c. prevents the enemy from being able to concentrate his return fire on one element of the defence.

### LAV Company Tactics (Interim)



**Figure 3-1: Area Defence General Concept**

4. **Size of Zulu LAV Kill Zone.** The maximum range from the Zulu LAV battle positions to the far end of the kill zone should not be greater than 1,800 m. The limiting factor is the maximum effective range of the 25 mm cannon against moving targets.

5. **Prepared Positions.** Light armoured vehicles do not normally occupy their battle positions. As with tanks, they usually remain in a hide until needed to occupy their battle positions. As for the positions themselves:

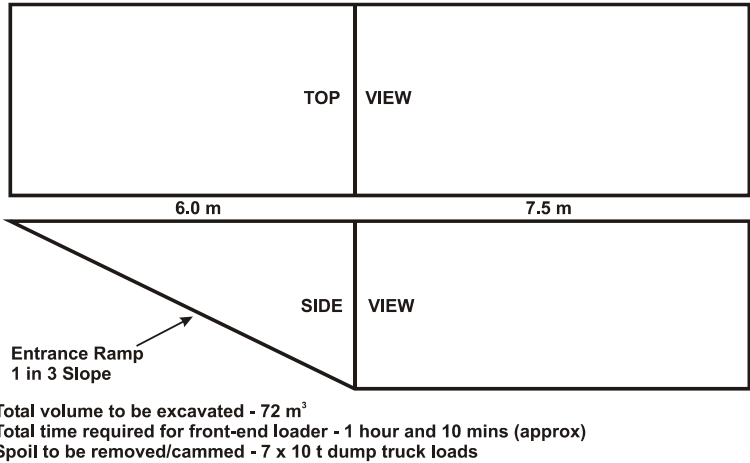
- a. **Number of Prepared Positions.** The number of positions for each LAV depends upon the threat, terrain and time available. Ideally, each LAV should have a:
  - (1) primary position—the most likely position to cover the main threat;
  - (2) alternate to primary position—a second location to cover the main threat; or
  - (3) secondary position—a position to cover another threat.

- b. **Selection of Prepared Positions.** Individual vehicle positions should be as spread out as possible while still allowing them to concentrate their fire on the kill zone and the LAV Sgt to maintain control of his Zulu platoon and to concentrate their fire on the kill zone. Such positioning reduces the danger from enemy artillery and cluster-type weapons. The following criteria apply to the selection of the prepared position:
- (1) covered route in from the hide and from other battle positions;
  - (2) terrain to allow for the adoption of turret-down and hull-down positions;
  - (3) terrain to allow for jockeying; and
  - (4) ability to cover the kill zone.
- c. **Preparation:**
- (1) The routes from the hide to each battle position and from each battle position to every other battle position must be recce and timings determined by day and by night. Route details are input into the TacNav system.
  - (2) Each initial LAV firing position should be marked with three stakes—one centred on the first and fourth left-hand side tires and one directly in front of the driver. This staking is done during the recce with an actual LAV in the hull-down fire position. Their purpose is to allow the vehicle to move, once ordered, directly from the turret-down to hull-down position with minimum time wasted and with the least chance of the vehicle being unnecessarily exposed.

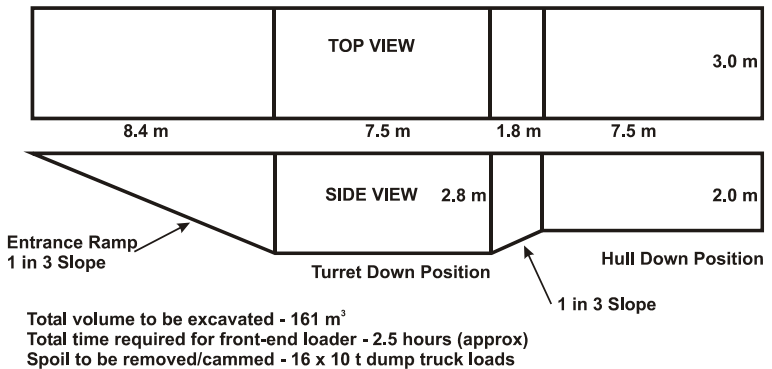
**NOTE**

The top of the stake directly to the driver's front must be at driver's eye level or higher. If not, the driver will lose sight of it as he gets close to it.

- (3) Range cards must be prepared by each crew and consolidated by the LAV Sgt. The LAV Capt prepares the company's light anti-armour template. The kill zone is divided up between the Zulu LAV platoons and, within each platoon's portion of the kill zone, individual vehicle arcs are assigned. The LAV Capt and LAV Sgts must ensure, however, that all areas of the overall kill zone that can be seen and/or engaged by any LAV are marked on that LAV's range card using company co-ordinated target reference points. This ensures that the fire of the maximum number of LAVs can be concentrated quickly and efficiently on any point within the kill zone. See Annex A for sample range cards.
  
- (4) If natural fire positions do not exist, it may be necessary to create them. This is a last resort as the engineer resources and time required to do so are formidable. Whenever possible, natural fire positions are preferred. After that, the preference is to improve natural positions. The construction is broken into two stages—stage one provides only a hull-down position, and stage two provides both hull- and turret-down positions.



**Figure 3-2: LAV Firing Position Stage 1—Hull-Down Position Only**



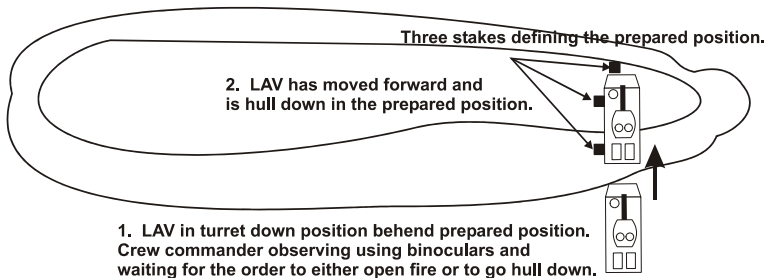
**Figure 3-3: LAV Firing Position Stage 2—Hull-and Turret-Down Positions**

6. **Sequence of Occupying Prepared Positions.** The LAVs are the largest, most difficult items to camouflage in the company. With the exception of a small number that are being used to reinforce the company's intelligence, surveillance, target acquisition and reconnaissance (ISTAR) capability, the remainder are normally in the hide until it is necessary for their battle positions to be occupied. When the command to occupy the battle positions is given:

## LAV Company Tactics (Interim)

- a. The Zulu LAV company follows the LAV Capt to the battle positions. As was stated above, the battle positions are rarely dug-in but, instead, are natural hull and turret-down positions that have been recced and staked in.
- b. It may be necessary for Zulu LAV platoons to proceed at least part of the way by themselves. In this case, a release point should be used. Regardless, the complete route, including the actual fire positions themselves, is programmed into the TacNav, and the cross-track setting should be used.
- c. All vehicles stop in turret-down positions facing their staked in prepared positions. They do not occupy them at this time but remain in turret-down positions.
- d. In good visibility, the LAV Capt, LAV Sgts and crew commanders observe the kill zone using binoculars from turret-down positions. In poor visibility, the LAV Capt and LAV Sgts may be given permission to adopt sights up positions to observe using thermal imagery (TI) and/or image intensification (II) sights. Given the possibility that surprise may be compromised, the decision to risk even partially exposing LAV turrets before the open fire is normally made by the company commander.
- e. Normally the Zulu LAVs do not occupy hull-down positions until the enemy light armour is within effective range and it is time to open fire. On the command **OPEN FIRE**, or when the enemy reaches a pre-designated open fire line, LAVs move forward from their turret-down positions into hull-down positions and begin to engage the enemy IAW the orders previously given. If it has been decided to occupy hull-down positions in advance of opening fire, then the command **HULL-DOWN NOW** is given.

- f. Upon receipt of either order, the driver advances into the prepared position, lining up the three stakes. Because the position has been recced and staked, the driver can move directly to the position without requiring further instructions from the crew commander or gunner. Once in position, the driver puts his foot on the brake and shifts into reverse to be able to jockey out of the position as quickly as possible when necessary.



**Figure 3-4: Occupying a Prepared Position**

**7. Conduct of the Battle:**

- a. The Zulu LAV company should occupy hull-down positions en masse and engage en masse. Zulu platoons should not be exposed individually as this invites all return fire, both direct and indirect, to be concentrated against one small area. The Zulu LAV company should begin engaging the light armour at the same time as the SRAAW(H) are engaging the tanks.
- (1) If the LAVs attempt to engage the light armour before the SRAAW(H) engage the tanks, then the tanks can concentrate their fire on the LAVs.
  - (2) If the LAVs wait for the SRAAW(H) to first kill the tanks before engaging the enemy light armour, the enemy light armour will probably have reached its dismount point before the LAVs engage.

- b. **Jockeying.** Once the battle has started, LAVs commence jockeying. The LAVs work in two-vehicle teams, the intent of which is to have one vehicle firing while the other vehicle is jockeying. Where terrain permits, the vehicle reappears in a new position. If not, the vehicle reappears in the same position but after a delay of 30 seconds to a minute. This is done to make it more difficult for the enemy to acquire his target. Additionally, if the crew commander believes that he is being targeted, he immediately orders a jockey. The sequence for a jockey is as follows:

- (1) Crew commander orders **JOCKEY RIGHT** (or **LEFT** or **REAR**).
- (2) Driver takes his foot off the brake and presses the accelerator to drive straight back, as quickly as he can.
- (3) Once the crew commander is satisfied he is in a turret-down position, he orders the driver to go right. The driver now heads diagonally back and right at a 45° (approximate) angle.

#### **NOTE**

It is extremely important that the vehicle is turret-down before the flank is turned toward the enemy.

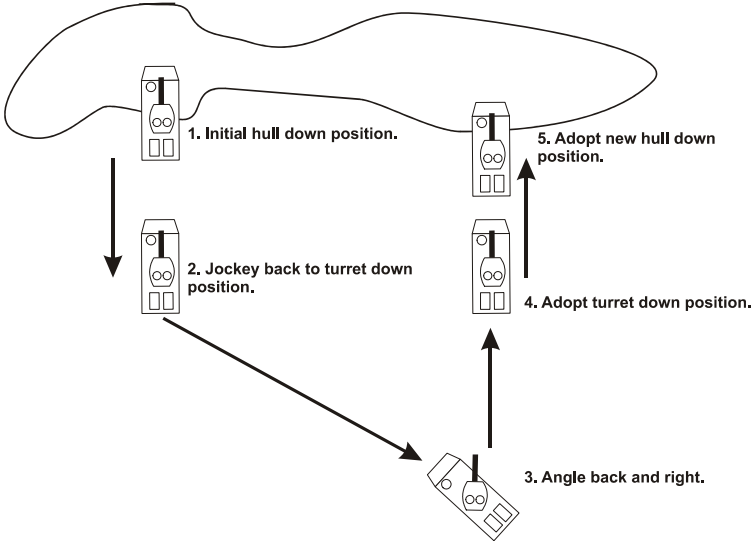
- (4) When the crew commander believes he has gone far enough to the right, he orders **DRIVER HALT**, and then direct the driver toward the new firing position. If possible, the LAV should move approximately 200 m laterally to help ensure it is not still in the enemy's sight when it reappears.
- (5) In good visibility, the crew commander first adopts a turret-down position before



adopting a hull-down position. In this case he orders: **DRIVER HALT. PREPARE TO ADOPT TURRET-DOWN.** The driver stops and shifts into Low. The crew commander orders **DRIVER ADVANCE** and directs the driver toward the turret-down position. Driver advances slowly, without using the accelerator, and with his foot resting on the brake.

- (6) Once in the turret-down position, the crew commander orders **HALT** and scans the kill zone using binoculars.
- (7) If the crew commander is still happy with his new firing position, he quickly briefs the gunner, giving him an anticipatory fire order and possibly roughly aligning the gun, and then orders **PREPARE TO ADOPT HULL-DOWN.** The gunner ensures the gun is at minimum elevation and oriented to the threat. The gunner then orders **DRIVER ADVANCE.** The driver advances straightforward, without using the accelerator and with his foot resting on the brake.
- (8) As soon as the gunner can see the kill zone through his sights, he orders **DRIVER HALT.** The driver stops, keeps his foot on the brake, and shifts into reverse.

## LAV Company Tactics (Interim)



**Figure 3-5: Jockeying to the Right**

- c. **Laser Warning Receiver.** If the enemy lazes before firing, the laser warning receiver should give the crew 2-5 seconds between the time the alarm goes off and when the round(s) arrive. If the laser warning receiver goes off when the LAV is occupying a hull-down position, the driver immediately, and without order, jockeys back. Once the vehicle is turret-down, the crew commander directs the driver into his jockey position.

8. **Ceasing to Jockey.** At some point in the battle, it may become essential to have the absolute maximum amount of fire on the kill zone. In this case, the order **NO JOCKEYING** is to be given. All vehicles adopt hull-down positions and remain in them until the battle is won or the order **RESUME JOCKEYING** is given. The order **NO JOCKEYING** should only be given if absolutely necessary as it greatly increases the chances of the Zulu LAVs coming under effective fire.

9. **Responsibilities.** The officer commanding is responsible for all aspects of the defence. As a rule, however, he delegates some authority to avoid having an unworkable span of control. The

command relationship for the Zulu LAVs is normally OPCOM to the company commander, or OPCON to the LAV Capt.

- a.       **Company Commander.** In addition to the overall conduct of the battle, the company commander is responsible for:
- (1)       refinement of the kill zone(s) and identification of approaches, both mounted and dismounted;
  - (2)       production of the consolidated company anti-armour plan;
  - (3)       selection and detailed layout of the dug-in company position(s) as well as the detailed fighting of the dismounted battle;
  - (4)       selection of the general location for Zulu LAV primary, secondary and alternate locations;
  - (5)       providing mission imposed priority of targets;
  - (6)       ordering the move of any portion of the company to alternate positions or committing the reserve;
  - (7)       ordering the ammo loads for the Zulu LAVs; and.
  - (8)       detailed siting of the assigned obstacle group.
- b.       **LAV Capt.** The LAV Capt is responsible for:
- (1)       detailed layout of all Zulu LAV positions;
  - (2)       construction of the light anti-armour plan as part of the consolidated anti-armour plan;

## LAV Company Tactics (Interim)

- (3) co-ordinating the LAV fire plan with the machine-gun (MG) matrix, in circumstances when the LAVs coax MGs could reasonably be brought into play as part of the company's defence against dismounted enemy;
- (4) detailed fighting of the Zulu LAVs, including concentration of fire and ordering Zulu platoons to secondary positions; and
- (5) construction of the company's ISTAR plan IAW the company commander's priorities.

### c. **LAV Sgt.** The LAV Sgt is responsible for:

- (1) detailed layout of the Zulu platoon's positions including:
  - (a) verification of routes in and out;
  - (b) verification of adequacy of hull-down, turret-down and jockey positions;
  - (c) verification of the ability of the assigned positions to cover the Zulu platoon's area of responsibility within the kill zone; and
  - (d) creation of an ISTAR trace for each of the Zulu platoon's positions;
- (2) breaking down the Zulu platoon's area of the kill zone into individual Zulu LAV portions; and
- (3) detailed fighting of the Zulu platoon including:

- (a) co-ordinating the Zulu platoon's fire;
  - (b) ordering jockeying if necessary; and
  - (c) leading the Zulu platoon to secondary or alternate positions as ordered.
- d. **Crew Commander.** The crew commander is responsible for:
- (1) preparation of all assigned positions including:
    - (a) verification of routes in and out;
    - (b) verification of adequacy of hull-down, turret-down and jockey positions;
    - (c) verification of the ability of the assigned positions to cover the Zulu LAV's area of responsibility within the kill zone; and
    - (d) creation of a range card for each prepared posn;
  - (2) inputting of all routes and key points into the TacNav; and
  - (3) detailed fighting of the vehicle, including the ordering of jockeying, as required.

10. **Other LAV Tasks:**

- a. **Other Tasks.** In addition to supporting the main defensive battle, Zulu LAVs can also be used for a variety of other tasks. These tasks include:

## LAV Company Tactics (Interim)

- (1) observation posts (see below);
- (2) reserve;
- (3) overwatch on probable landing/drop zones (LZs/DZs);
- (4) emergency resupply;
- (5) casualty evacuation; and
- (6) flank screen, if operating alone, or guard if paired with adequate heavy anti-armour resources.

- b. **Effect on the Main Defensive Battle.** The LAVs are the company's prime anti-LAV weapons system and the major factor in determining whether enemy APCs reach their dismount point. Within the company defensive context, Zulu LAVs should not be assigned tasks that take them away from the main defensive battle unless those tasks are essential.

11. **Observation Posts.** The LAV turret sensors (8 power day, 4/8 power TI and 8 power II), combined with the far target indicator, provide the company with a potent surveillance and target acquisition capability to reinforce its dismounted sensors. A limited number of vehicles should be used to reinforce the company's ISTAR plan:

- a. **Ranges.** The ranges of the various sensors are given in section 1-4 and are for an operator trained to level 2 armoured fighting vehicle (AFV) recognition in both visual and thermal. During periods of low thermal contrast, the ranges for the TI is reduced. During periods of low ambient light, the ranges for the II is reduced.
- b. **Siting:**
- (1) The sight heads are on the top of the turret. The vehicle should be sited so that, ideally, only the sight heads are visible.

- (2) There should be a covered approach for the LAV to the OP location.
- (3) There should be cover from both ground and air observation.

c. **Camouflage and Concealment:**

- (1) The issued camouflage net should be used to supplement natural camouflage.
- (2) The vehicle should remain on silent watch as long as possible. To extend the time on silent watch:
  - (a) turret traversing and elevating should be done manually;
  - (b) radio speakers should be off; and
  - (c) all non-essential power draws, such as the heating and boiling vessel and the interior lights, should not be used.
- (3) The crew heater should not be used as it increases the vehicle's thermal signature.
- (4) When the batteries must be recharged, it should be done with the auxiliary power unit (APU) and, if possible, before dusk or after dawn.
- (5) The vehicle and crew should be as self-sufficient as possible for at least 48 hours so as to minimize the chance of the location being compromised during replenishment.

d. **Manning.** A two-person turret crew plus a driver with no turret training cannot maintain a continuous, systematic watch over the battlefield for a prolonged period, maintain local security and have adequate

## LAV Company Tactics (Interim)

time for rest and food. Ideally, all soldiers in the section should have LAV familiarization training and be qualified level 2 AFV recognition, including thermal. Manning of a LAV observation post for more than short periods is a section task. The ideal manning of the turret in temperate weather is two personnel for two hours—one gunner or crew commander qualified and the other turret familiarization training qualified. This allows:

- (1) the two soldiers to spell one another off while still having a qualified person always in the turret;
- (2) staggering of the shift rotation so that every hour a fresh person is coming on while maintaining someone else in the turret for continuity; and
- (3) adequate numbers to do all the tasks needed to support the observation post.

### NOTE

In cold weather, the shift length must be reduced.

## MOBILE DEFENCE

12. **General.** The mobile defence uses a series of battle positions to shape, wear down and destroy the enemy as he advances. The enemy is then finally fixed and destroyed. No individual battle position is of particular importance. In open country, emphasis is placed on the use of mobile, long-range weapon systems as opposed to dismounted infantry.

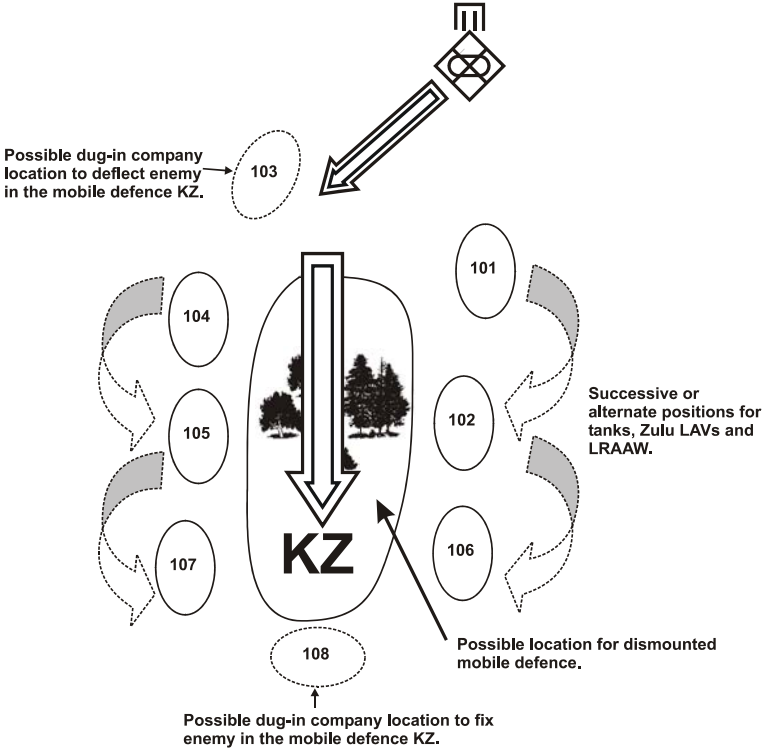
13. **Combined Arms Team.** The LAV company lacks the organic long-range anti-armour weapons (LRAAWs) to conduct a mobile defence by itself against armoured forces. It normally takes part in the mobile defence as part of a combat team.



14. **Tasks:**

- a. **LAVs.** LAVs support the tanks and LRAAWs in the destruction of the enemy's armour. LAVs concentrate on killing the enemy's light armour, particularly anti-tank guided missile (ATGM) launchers, to allow the tanks and LRAAWs to kill tanks.
- b. **Infantry.** The dismounted infantry themselves have little ability to support the long-range battle. If they are dismounted, their weapons are out of range, they are very vulnerable to indirect fire, and they slow down the redeployment of friendly forces to the next battle position because of the need to remount before moving. If infantry stay in the vehicles, they have no function but to add casualties if the vehicle is hit. Instead, the infantry should be used for:
  - (1) **Area Defence.** Even within a mobile defence, there are areas of key terrain that the commander wants held. Properly sighted, these positions can help channel the enemy toward the mobile defence kill zones. Alternately, the dismounted infantry can form the framework for the final fixing position within the mobile defence that sets up the ultimate destruction of the enemy.
  - (2) **Dismounted Mobile Defence.** Dismounted infantry can be sighted to conduct a mobile defence in areas of difficult going for armoured forces. To be effective, the terrain must allow the dismounted infantry to engage an armoured force at no greater than 600 m, impose casualties and then successfully withdraw.

LAV Company Tactics (Interim)



**Figure 3-6: Mobile Defence General Layout**

**ANNEX A  
LAV RANGE CARD**

<b>Legend / Légende</b>							
Description	Symbol Symbole	Description	Symbol Symbole	Description	Symbol Symbole	Description	Symbol Symbole
<b>Notes</b>							



## CHAPTER 4 DELAY

1. **General.** As with the mobile defence, the delay uses a series of battle positions to shape, wear down and destroy the enemy as he advances with the aim of providing time for other tasks. No individual battle position is of particular importance. In open country, emphasis is placed on the use of mobile, long-range weapon systems as opposed to dismounted infantry.

2. **All-arms Team.** The light armoured vehicle (LAV) company normally conducts delay operations in an all-arms framework. The company by itself lacks the heavy anti-armour firepower at medium and long ranges necessary to stand up to enemy tank forces:

3. **Tasks:**

a. **LAVs:**

- (1) LAVs assist in the delay battle by destroying enemy LAVs, in particular anti-tank guided missile (ATGM) launchers, to allow the tanks to concentrate on enemy tanks.
- (2) LAVs provide the best all-arms air defence (AAAD) asset in the battle group. Some LAVs may be tasked to provide AAAD for the combat team.

b. **Dismounted Infantry and SRAAWs.** The dismounted company and its short-range anti-armour weapons (SRAAWs) are not normally employed in the medium- to long-range delay battle. Instead, they will:

- (1) be preparing the main defensive position;  
or
- (2) conduct a separate, dismounted delay in close country.

4. **Method of Engagement:**

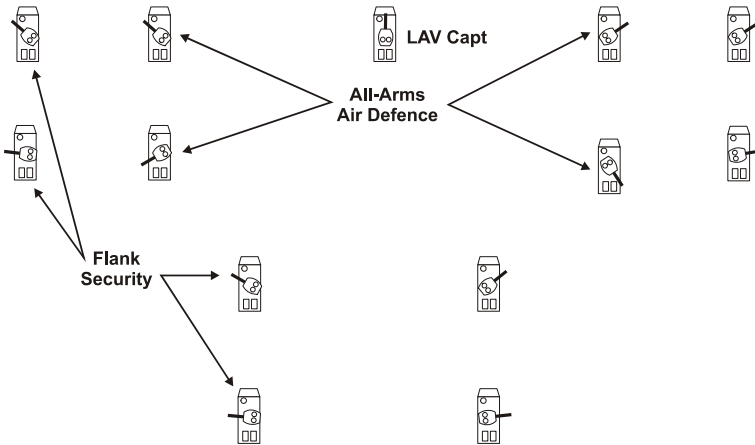
- a. The tanks out range the LAV. This is exacerbated by the fact that the LAV's targets—enemy armoured personnel carriers (APCs) and ATGM launchers—normally travel behind the enemy tanks. The company commander / LAV Capt must ensure that the LAVs are not exposed to enemy fire before their targets are within range. It will not be unusual for the commander to order the move to the next position without the LAVs having been engaged.
- b. Once the enemy LAVs have come within range, the company commander / LAV Capt orders the LAV company to move into fire positions. All LAVs move simultaneously to:
  - (1) hit the enemy with an initial burst of fire as hard as possible; and
  - (2) make it impossible for the enemy to concentrate his return fire on only a few LAVs.

## CHAPTER 5 TRANSITIONAL PHASES

### ADVANCE TO CONTACT

1. **General.** The mechanized advance to contact normally takes place in a combat team setting. In particular, mechanized infantry do not advance against an enemy who has tanks without tanks of their own. Details of the combat team in the advance to contact are provided in B-GL 321-006/FP-001 *Combat Team Operations*. Some amplification of the role and tasks of the infantry is provided below.
2. **Movement.** The light armoured vehicle (LAV) company normally moves behind the tanks from positions of cover to positions of cover while maintaining observation. Despite the LAV's increased firepower and protection over previous armoured personnel carriers (APCs), its gun is still out ranged by the tank's and its armour is much inferior. Instead, the LAVs concentrate on flank security and all-arms air defence (AAAD).
  - a. **Flank Security.** Outside LAVs maintain a constant watch on the flanks to engage any threats.
  - b. **All-Arms Air Defence.** The 25 mm turret is the best AAAD weapon available. Inside LAVs should normally be tasked with 360° AAAD.

### LAV Company Tactics (Interim)



**Figure 5-1: LAV Company Behind the Tanks in the Advance**

3. **Location of Commanders.** The company commander moves with the squadron commander. The LAV Capt moves with the company and controls its movement. The company 2IC moves with the A1 echelon but does not command it.

4. **Advance to Contact without Tanks.** As stated above, the LAV company rarely conducts advance to contact outside of a combat team. Some operations, such as reacting to a rear area incursion or advancing on a secondary axis, may require the LAV company to either advance to contact or advance in contact without integral tank support. Under those circumstances, the LAV company must provide its own security as it moves. To do so, it moves in a manner similar to the tank squadron:

a. **Fire Position to Fire Position.** The company moves in bounds from fire position to fire position. Both groups of LAVs must remain in contact with one another if effective support is to be maintained. This overwatch is vital if security is to be maintained.

b. **Direct Fire Support:**

- (1) The company provides its own internal fire support on the move. This is usually one platoon set supporting the other two



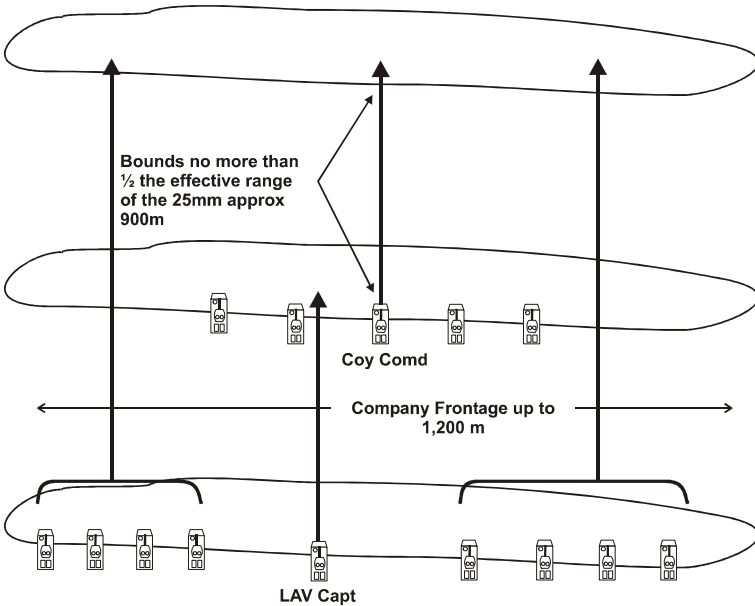
forward and then two platoons set supporting the third platoon forward. Depending on terrain and threat, platoons can provide their own support with two vehicles supporting the other two and, if necessary, each team of two vehicles can be broken down into one moving and one supporting. At this point, however, the commander must question whether it would not be faster to have the infantry dismount and move in front of the Zulu LAVs.

- (2) In any of the above options, the company can move in either leapfrog or caterpillar formation.
- (3) **Location of Commanders.** Between the two of them, the company commander and the LAV Capt control the movement of the company. One commander will normally be with the forward element (one platoon if the company is advancing one-up or two platoons if two-up) and one will move with the rear element. The company commander will decide, based on the circumstances, whether he will always be with the forward element, always with the rear or will alternate. Regardless as to which commander is with the forward element, he must ensure that he does not become the prime target for the enemy. Therefore, as guidelines:
  - (a) The company commander / LAV Capt do not physically lead the forward element over the bound to their next fire positions.
  - (b) Company command / LAV Capt vehicles should not be the first to move into the new fire positions. The lead platoon(s) should be

## LAV Company Tactics (Interim)

allowed to establish itself first and search the ground.

- (c) The company commander / LAV Capt is there to oversee as opposed to fight. He should



choose a position of observation that provides him maximum cover.

**Figure 5-2: LAV Company Using Leap Frog—One Platoon Supporting the Other Two**

## WITHDRAWAL

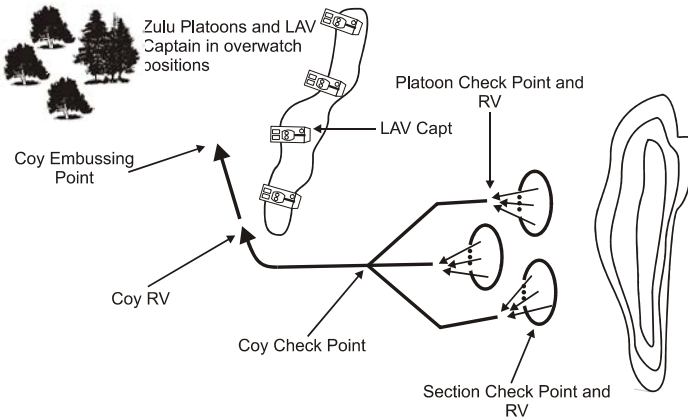
5. **General.** The LAV company can withdraw in one of two basic manners. The first is the traditional withdrawal from the battle position on foot, through a series of checkpoints and RVs, until arriving at the company embussing point. In the second manner, the company embusses much further forward, normally at the section RV.

6. Withdrawal on foot to a company embussing point:

- a. **General.** In the traditional withdrawal on foot, the commander is trading decreased speed for increased stealth. The conventional withdrawal on foot to a company embussing point is used when:
- (1) the commander believes he can withdraw unseen;
  - (2) the route for the LAVs to the company position is dominated by enemy anti-armour fire; or
  - (3) the route to the company position is impassable or extremely difficult for vehicles.
- b. **Preparation:**
- (1) Normal thinning out is conducted as with all withdrawals. Additionally, LAV positions where the LAVs can support the withdrawal must be recced and, if necessary, prepared. Ideally, the LAV battle positions are used. It may be necessary to select new ones, however, depending on the dismounted withdrawal route. The selection of these positions and the recces of the routes both to the positions and from the positions to the company embussing point are the LAV captain's responsibility. All positions, and the routes between them are programmed into the TacNav systems.
  - (2) The LAVs also have the company's dismounted withdrawal routes programmed into their TacNav systems. This is for the contingency that the dismounted withdrawal becomes untenable, and the LAVs must move forward to pick up the soldiers before the embussing point.

## LAV Company Tactics (Interim)

- c. **Conduct.** LAVs may or may not support the dismounted company's withdrawal from positions of observation and fire but may, instead, move directly to the embussing point. The commander makes this decision based on his estimate. If LAVs are used to support the withdrawal from positions of observation and fire:
- (1) The LAVs should arrive at their support positions just before the dismounted withdrawal begins. If visibility is good, they remain in turret-down positions and the crew commanders scan using binoculars. In poor visibility, they adopt hull-down positions and scan using the thermal imagery (TI).
  - (2) Just before the first platoon withdraws, all LAVs adopt a hull-down position and scan their arcs.
  - (3) The Zulu LAVs maintain their support to the withdrawing troops throughout their move back to the embussing point. As the dismounted company approaches the embussing point, the LAVs move under command of the LAV captain to link up with the company.



**Figure 5-3: Dismounted Withdrawal**

7. Mounted withdrawal from the section rendezvous:

- a. **General.** The mounted withdrawal trades off the chance of being able to withdraw from the position unseen for far greater speed of withdrawal. It is particularly appropriate where it is likely that the enemy would be able to bring indirect fire on the withdrawing infantry and would be unlikely to be able to launch a quick counter move once he becomes aware that the withdrawal is underway. It is not appropriate when the route the LAVs would have to travel to the section locations is dominated by enemy anti-armour weapons or is impassable to vehicles.
- b. **Preparation.** Normal thinning out is conducted as with all withdrawals. Speed is the key to this method as it is impossible to prevent the enemy from knowing something is happening once the LAVs move to the dug-in location. To ensure that the LAVs can move at high speed, the routes should be reced in detail. Specifically:
  - (1) Routes must be chosen so that they avoid obstacles, bad ground, dismounted troop locations, etc. If different Zulu platoons are using different routes, they must be coordinated to ensure that they do not

LAV Company Tactics (Interim)

interfere with one another. This is the LAV captain's responsibility.

- (2) The specific route for every vehicle should be programmed into its TacNav system. The routes should be walked with a global positioning system (GPS) to record key waypoints. Certainly, the location of all embussing points must be recorded using GPS. It is the LAV Capt's responsibility to ensure that all routes are entered into the vehicle GPSs.
- (3) Embussing points must be as close to the sections as possible and normally are no more than 20 m behind the section trenches.

c. **Conduct.** As stated earlier, surprise and speed are the keys to success. The Zulu LAVs must move to the dug-in company and off the position before the enemy has time to react with anything other than indirect fire:

(1) **Stage 1—Move to the Assembly Area:**

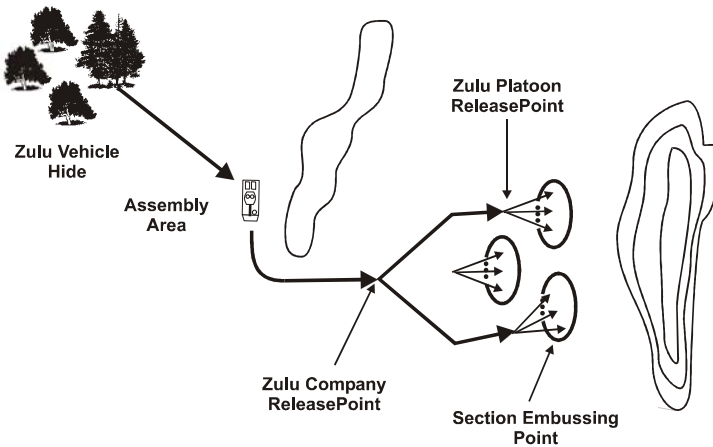
- (a) **Zulu Company.** The Zulu company moves under command of the LAV captain from the hide to the assembly area. Both the assembly area and the route to it must be covered. To maintain surprise, the Zulu company should not move to the assembly area until just before the withdrawal is scheduled to begin. Ideally, the assembly area should be treated like the attack position, and the Zulu company should roll through it in its correct order.
- (b) **Dug-in Company.** No change.

- (2) **Stage 2—Move to the Embussing Point:**
- (a) **Zulu Company.** The Zulu company moves from the assembly area to the individual vehicle embussing points. The drivers follow the TacNav directions automatically unless they are countermanded by the crew commanders. The crew commanders are usually hatches up confirming the route visually, using image intensification (II) goggles at night. Depending upon the situation, the Zulu company may move in one of two ways:
- i. **Single Route.** The single route provides the most positive control. The Zulu company moves, initially, on a single route with the platoon that has the furthest to go leading. At the Zulu company release point (programmed into the TacNav system), the Zulu platoons move to platoon routes. Once the Zulu platoon reaches the platoon release point (programmed into the TacNav system), the individual Zulu vehicles proceed directly to their individual embussing points.

**Figure 5-4: Mounted Withdrawal Stages 1 and 2—Single Route**

- ii. **Individual Zulu Platoon Routes.** If the dug-in platoons are well spread out, individual Zulu platoon routes may be the fastest method of moving to the embussing point(s). Each Zulu platoon proceeds directly from assembly area to its own dug-in platoon location. The action at the Zulu platoon release point is as above.

(b) **Dug-in Company.** No change.

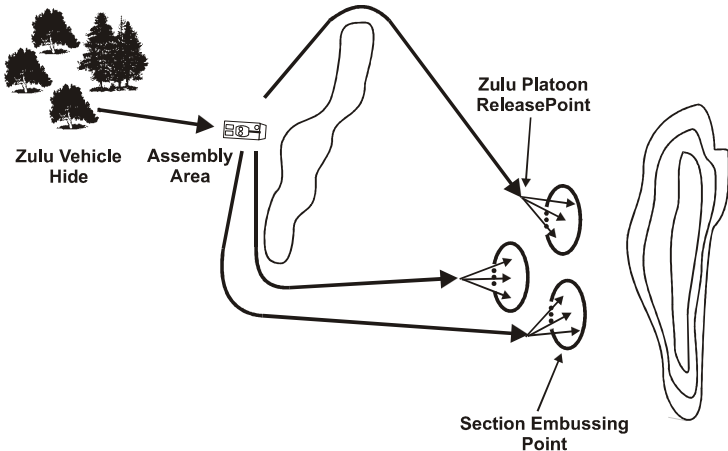




**Figure 5-5: Mounted Withdrawal Stages 1 and 2—Individual Zulu Platoon Routes**

(3) **Stage 3—Action at the Embussing Point:**

- (a) **Zulu LAV Company.** As each vehicle reaches its embussing point, it stops in the best available cover, ensures the gun is covering the main threat and drops the ramp. The crew commander watches for the section and is prepared to provide assistance as required.
- (b) **Dug-in Company.** The dug-in section does not leave its trenches



until its own LAV arrives. This is to ensure that the soldiers are protected from indirect fire until the last moment and to ensure the soldiers on the ground are not run over by other LAVs. Once the LAV arrives:

- i. The section, led by the section 3IC, moves to the LAV and mounts up.

LAV Company Tactics (Interim)

- ii. The dismounted section commander confirms that all trenches are empty and then moves to the LAV and mounts up.
- iii. The dismounted section commander physically confirms that all his soldiers are in the vehicle and reports this to the platoon commander via the radio. The platoon commander conducts the same count for platoon HQ and then reports via the radio to the company commander when his platoon complete has mounted up.
- iv. If some Zulu LAVs have been destroyed by the enemy en route, the platoon commander divides his troops between the remaining LAVs.
- v. There is no change round in the turrets at this time.

(4)

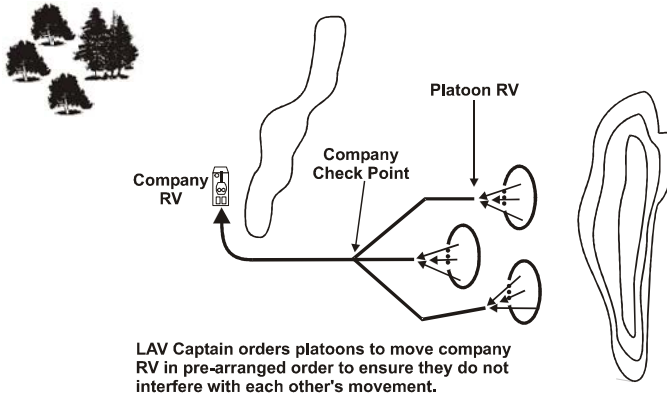
**Stage 4—Move to the Company RV.**

Once the sections are mounted, they move to the platoon RV. This is right behind the platoon and may be the same location as the platoon release point. Platoons stay in the RV for the minimum possible time.

The platoons then move to the company RV, through the company checkpoint, under the direction of the LAV captain.

This move may take place in one of two ways—a single route or separate platoon

routes. The company commander's vehicle is the last LAV to leave the position, and only when he is satisfied that all other personnel have withdrawn:

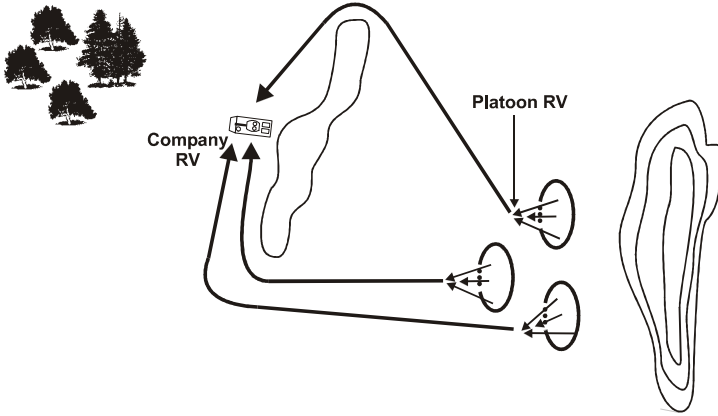


(a) **Single Route:**

- i. If there is a single route to the company RV, the LAV captain orders platoons to head to the RV in a pre-arranged sequence. Normally, the platoon closest to the RV is ordered to move first, followed by the next closest, and so on with the LAV captain following the last platoon.
- ii. This method imposes the most centralized control on the process but takes longer to execute and is more dependent on radio communications.

**Figure 5-6: Mounted Withdrawal Stages 3 and 4—Single Route**

LAV Company Tactics (Interim)



(b) **Separate Platoon Routes:**

- i. If there are separate platoon routes, platoons normally move to the RV as soon as they are mounted up, advising the company commander and LAV captain as opposed to requesting permission. The LAV captain moves to the RV as soon as the last platoon has advised that it is moving.
- ii. This method is faster and less dependent on radio communications. It has more potential for confusion, however, with the possibility of three platoons moving at speed at night on converging axes.

**Figure 5-7: Mounted Withdrawal Stages 3 and 4—Individual Zulu Platoon Routes**

- (5) **Stage 5—Action at the RV.** The company RV is commanded by the company sergeant-major (CSM). At the RV:
- (a) The CSM establishes an all around defence. If vehicles are expected to be in location for longer than five minutes, or if the CSM deems it necessary, dismounted security is established. The dismounted security remains close to their vehicles, however, to prevent confusion on the ground and allow them to remount quickly.
  - (b) Any change arounds necessary in the turrets are completed.
  - (c) Any confirmatory orders necessary are given, and the company prepares to move off.
  - (d) The LAV captain confirms that all company vehicles are moving. His is the last vehicle to leave the RV.

8. **Rear Guard.** Regardless of the method of withdrawal, it may become necessary to form a rear guard to allow the main body to break clean. The rear guard is commanded by the LAV captain and usually consists of a platoon.

## **RELIEF IN PLACE**

9. The relief in place is covered in detail in B-GL 321-006/FP-001, *Combat Team Operations*.

LAV Company Tactics (Interim)

**PASSAGE OF LINES**

10. Passage of lines is covered in detail in B-GL 321-006/FP-001, *Combat Team Operations*.

## ANNEX A OBSTACLE HELD-UP AND CONTACT DRILLS

1. **General.** Contact and held-up drills for the combat team are found in B-GL-321-006 FP-001, *Combat Team Operations*. This annex details the drills used by the LAV company when operating without tanks. The term “held-up” is used for natural obstacles and inadvertent man-made ones such as a village. The term “contact” is used for deliberately emplaced obstacles such as a roadblock or minefield. The difference in terms acknowledges that while the natural or inadvertent obstacles may or may not be covered by fire, the deliberately emplaced obstacles almost certainly are.
  
2. **Sequence.** All drills follow the same basic sequence:
  - a. **Warning.** Lead elements report the obstacle using either “held-up” or “contact” and then a report as to the nature of the obstacle.
  
  - b. **Security.** The commander ensures that his force deploys in a manner that allows fire to be brought to bear on the obstacle as well as maintain the overall security of his force from both direct and indirect fire.
  
  - c. **Recce.** The commander either conducts a recce or orders one to be conducted for him. This may be as simple as the commander looking at the obstacle through a set of binoculars.
  
  - d. **Plan.** Based on the recce and the overall situation, the commander makes a plan.
  
  - e. **Execution.** The plan is executed, the obstacle overcome, and the force moves on.
  
3. **Speculative Fire.** Speculative fire can be used in any of the drills in an attempt to draw the enemy into exposing himself before forces are committed to the clearing of the obstacle. Circumstances will determine whether it is appropriate.

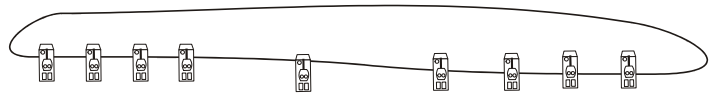
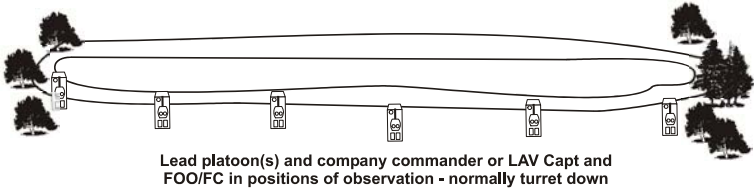
LAV Company Tactics (Interim)

4. **Enemy Contact.** If the enemy is contacted during the drill, the drill ceases and the commander revises his plans as appropriate.

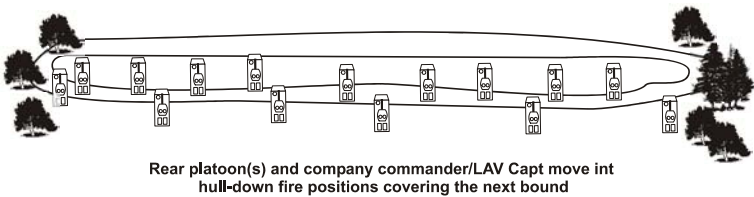
5. **Crest Drill.** The crest drill is used when the company must crest. If practicable, the company should attempt to avoid cresting by moving to the flanks of the hill/crest. It is appreciated that this cannot always be accomplished or that this course may lead the platoon into even more dangerous potential enemy kill zones. When the company does crest, the standard drill is:

- a. **Warning.** Lead platoon(s) report **HELD-UP CREST.**
- b. **Security.** Company adopts position of cover and concealment.
- c. **Rece.** Lead platoon(s) and the forward observation officer / fire controller (FOO/FC) adopt positions of observation to see beyond the crest versus positions of fire. In good visibility, this is likely to be turret-down positions, though the commander may choose to partially expose some turrets in sights-up positions so that their TI can be used.
- d. **Plan/Execution.** Upon the lead elements reporting that there does not appear to be any enemy, the rear platoon(s) adopts fire positions to cover forward of the crest. The lead platoon(s) then jockey and cross the crest simultaneously in new locations. At the end of the bound, the lead platoon(s) establishes itself in fire positions and covers the move of the rear platoon(s) off the crest. The rear platoon(s) move off the crest in the same manner as the forward platoon(s).





**Figure 5A-1: Crest Drill—Part 1**



**Figure 5A-2: Crest Drill—Part 2**

## LAV Company Tactics (Interim)

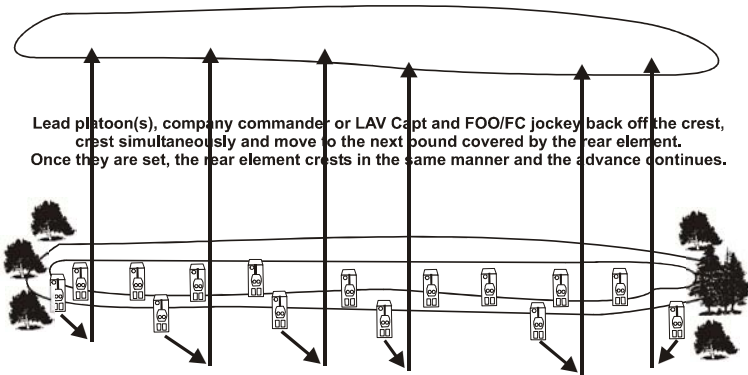


Figure 5A-3: Crest Drill—Part 3

6. **Gap Drills—General.** This drill covers the action of the LAV company from identification of a gap that presents a threat to a flank until the company has moved beyond the gap. The gap can be cleared dismounted, or the company can push past mounted using fire and movement to reduce the threat. Clearing dismounted is more secure but takes significantly longer. Smoke and speculative fire can be used as the commander deems appropriate and the situation allows.

a. **Gap Drill—Gap Cleared by Dismounted Infantry:**

- (1) **Warning.** Lead element that encounters the gap reports **HELD-UP GAP RIGHT/LEFT** and moves into a position of observation.
- (2) **Security.** The lead elements move into fire positions to cover both the gap and the axis of advance. The FOO/FC moves to a position where he can call down fire on either the gap or the axis of advance. The remainder of the company moves into a position of cover.
- (3) **Recce.** The company commander moves to where he can see both the gap and the axis of advance.

- (4) **Plan/Execution.** The commander decides to clear the gap with dismounted infantry.
- (a) The company commander assesses whether clearing the gap will require a rifle section or an entire platoon and tasks a section or platoon from the rear element.
  - (b) The commander of the tasked element moves forward to see the ground and to liaise with the platoon providing overwatch. Speculative fire may be used to attempt to draw the fire of any enemy in the gap.
  - (c) The tasked element moves down to the gap, either on foot or in vehicles depending on the circumstances. Regardless, those who clear the gap on foot will carry the short range anti-armour weapon (heavy) (SRAAW[H]) with them.

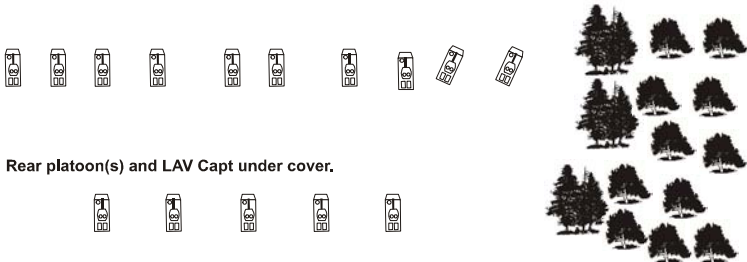
#### NOTE

To physically clear a gap so that no fire can be brought to bear on a force moving past it could take a very long time, especially given the range of modern dismountable ATGMs (anti-tank guided missiles). Under most circumstances the clearing force will only be able to move to a position inside the gap where they can see down it.

- (d) Once the gap is reported clear, the company continues with the advance and the clearing element is picked up.

# LAV Company Tactics (Interim)

Lead platoon(s) and FOO/FC providing security to the front and on the gap. Company commander in position of observation to complete his recce.

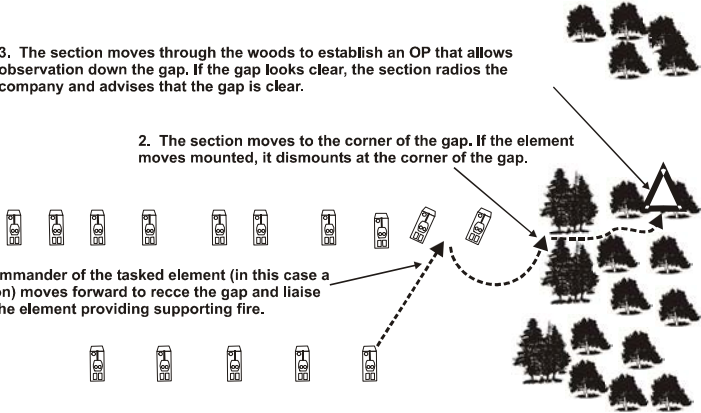


**Figure 5A-4: Gap Drill—Clear with Dismounted Infantry—Part 1**

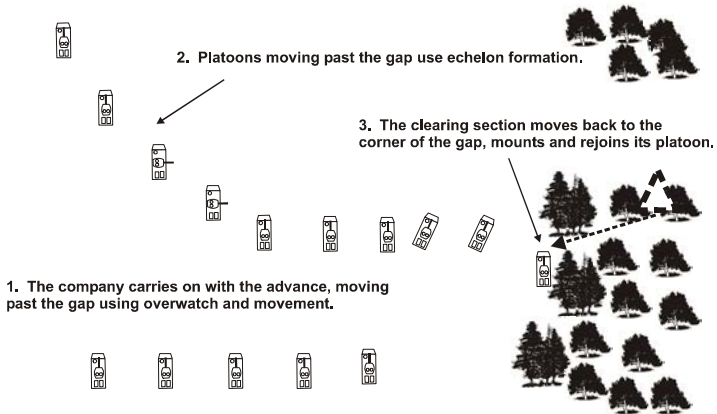
3. The section moves through the woods to establish an OP that allows observation down the gap. If the gap looks clear, the section radios the company and advises that the gap is clear.

2. The section moves to the corner of the gap. If the element moves mounted, it dismounts at the corner of the gap.

1. Commander of the tasked element (in this case a section) moves forward to recce the gap and liaise with the element providing supporting fire.



**Figure 5A-5: Gap Drill—Clear with Dismounted Infantry—Part 2**



**Figure 5A-6: Gap Drill—Clear with Dismounted Infantry—Part 3**

- b. **Gap Drill—Gap not Cleared with Dismounted Infantry.** If time or speed is critical, such as in the pursuit, or if the commander judges the risk to be acceptable, he may choose to move past the gap without clearing it:
- (1) **Warning.** Lead element that encounters the gap reports **HELD-UP GAP RIGHT/LEFT** and moves into a position of observation.
  - (2) **Security.** The lead elements move into fire positions to cover both the gap and the axis of advance. The FOO/FC moves to a position where he can call down fire on either the gap or the axis of advance. The remainder of the company moves into a position of cover.
  - (3) **Recce.** The company commander moves to where he can see both the gap and the axis of advance.
  - (4) **Plan/Execution.** The commander decides to not clear the gap with dismounted infantry.

LAV Company Tactics (Interim)

- (a) The company commander orders the platoon that can best cover the gap and the FOO/FC to remain in location.
- (b) The other two platoons, in succession, move past the gap using echelon formation and into fire positions beyond the gap. Suppressive fire and smoke may be used as appropriate.
- (c) The last platoon and the FOO/FC move past the gap using echelon formation.



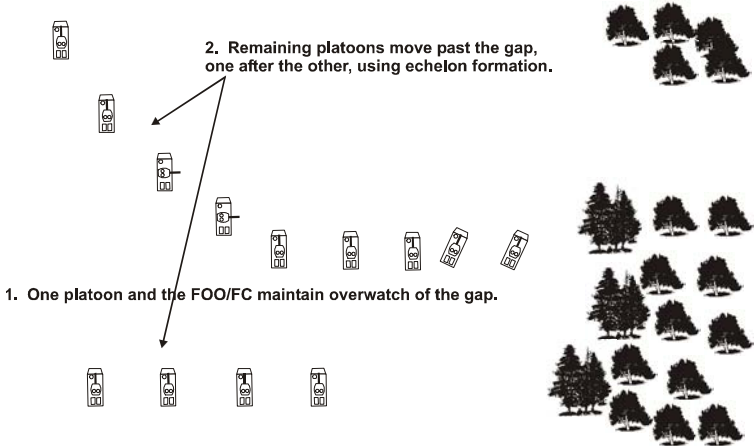
Lead platoon(s) and FOO/FC providing security to the front and on the gap. Company commander in position of observation to complete his recce, normally turret down.



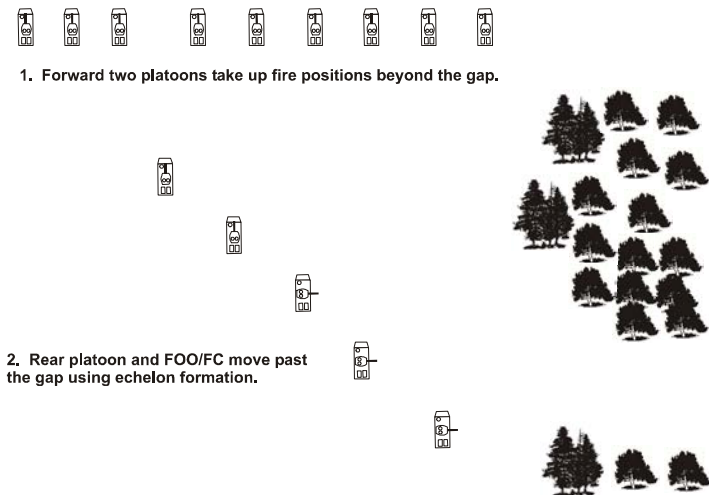
Rear platoon(s) and LAV Capt under cover.



**Figure 5A-7: Gap Drill—Gap not Cleared with Dismounted Infantry—Part 1**



**Figure 5A-8: Gap Drill—Gap not Cleared with Dismounted Infantry—Part 2**



**Figure 5A-9: Gap Drill—Gap not Cleared with Dismounted Infantry—Part 3**

7. **Defile Drills—General.** Defiles are defined as short or long. A short defile is one where the end of the defile can be seen from the mouth of the defile. A long defile is one where the end of the defile cannot be seen from the mouth. Defiles can be cleared either mounted or dismounted. It is a command decision based upon the threat and time constraints. Clearing dismounted is more secure but takes longer. On a short defile, the FOO/FC and engineer/pioneer (engr/pnr) do not

accompany the clearing element because they can see the length of the defile from outside the defile. On a long defile, they follow the clearing platoon.

- a. **Defile Drill—Defile Cleared by Dismounted Infantry:**
  - (1) **Warning.** The lead elements of the company report **HELD-UP—SHORT/LONG DEFILE** and move into a position of observation.
  - (2) **Security.** The remainder of the company moves into a covered location, and the lead element ensures that it can quickly move from positions of observation overlooking the defile to positions of fire.
  - (3) **Recce.** The company commander and the FOO/FC move to a position overlooking the defile.
  - (4) **Plan/Execution.** The company commander decides to clear the defile dismounted:
    - (a) The company commander orders one of the depth platoons to move to the mouth of the defile and clear the defile.
    - (b) The lead element moves from positions of observation to fire positions and prepares to cover the move of the clearing platoon.
    - (c) The clearing platoon moves either mounted or dismounted, depending on the circumstance, to the mouth of the defile.



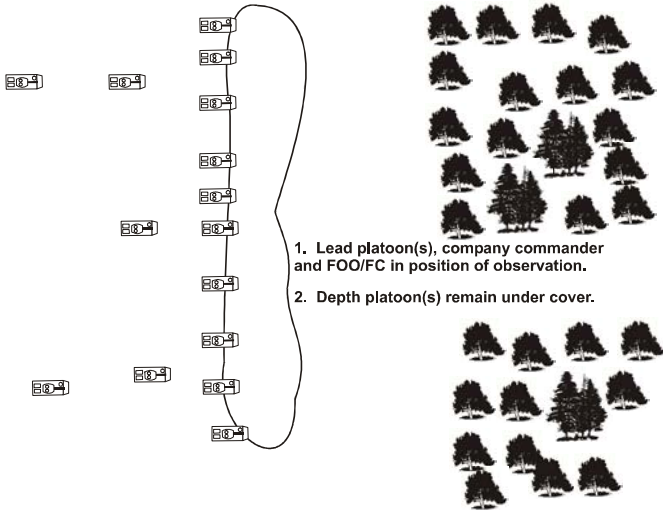
- (d) At the defile, the clearing platoon dismounts, if it moved mounted, and clears both sides of the defile. One or more Zulu LAVs move with the dismounted platoon to provide intimate support. The depth section can either remain mounted at the entrance to the defile or follow on foot.

### NOTE

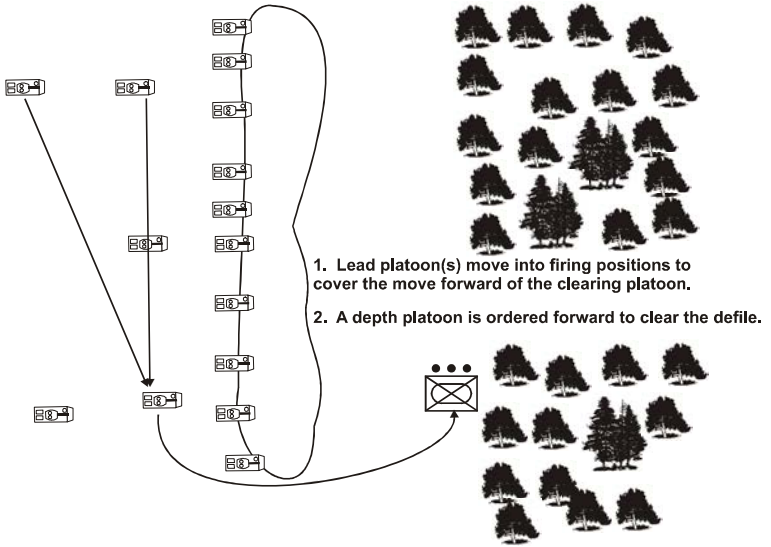
If the defile shown in the example below were a long defile, the clearing platoon would be followed by FOO/FC and engr elements.

- (e) At the far end of the defile, the dismounted platoon and intimate support LAVs take up fire positions and report the defile clear.
- (f) The remainder of the company moves through the defile, one platoon at a time, takes up fire positions at the far end and prepares to take up the advance. Succeeding LAVs alternate in covering left and right with their turrets, while soldiers in the air sentry hatch cover the areas not being covered by the turret. Crew commanders must ensure that their vehicles are far enough away from the edge of the defile—no closer than 20 m—so that the turrets can bring down effective fire if needed.
- (g) Lastly, the remaining Zulu LAVs and depth section of the clearing

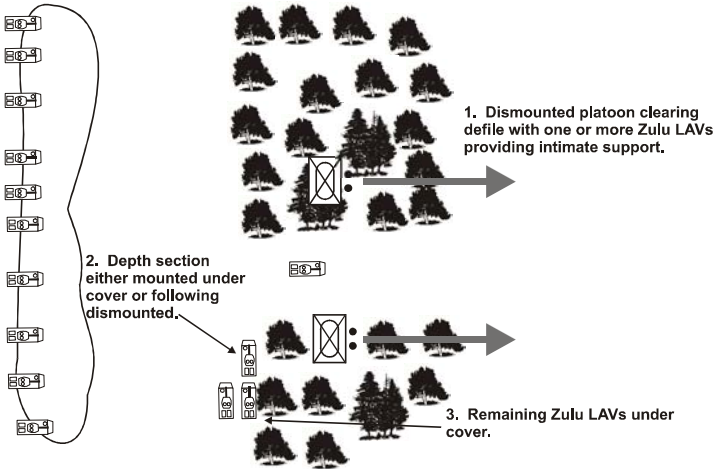
platoon pass through. The clearing platoon remounts and takes up the rear on the advance.



**Figure 5A-10: Defile Drill—Defile Cleared with Dismounted Infantry—Part 1**



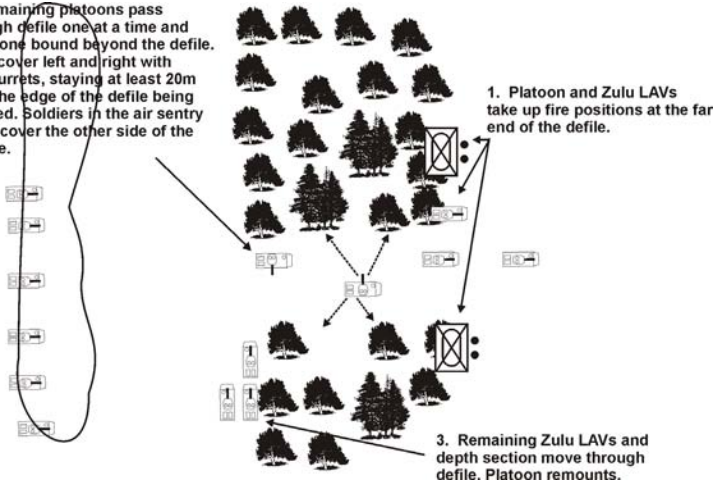
**Figure 5A-11: Defile Drill—Defile Cleared with Dismounted Infantry—Part 2**



**Figure 5A-12: Defile Drill—Defile Cleared with Dismounted Infantry—Part 3**

## LAV Company Tactics (Interim)

2. Remaining platoons pass through defile one at a time and move one bound beyond the defile. LAVs cover left and right with their turrets, staying at least 20m from the edge of the defile being covered. Soldiers in the air sentry hatch cover the other side of the vehicle.



**Figure 5A-13: Defile Drill—Defile Cleared with Dismounted Infantry—Part 4**

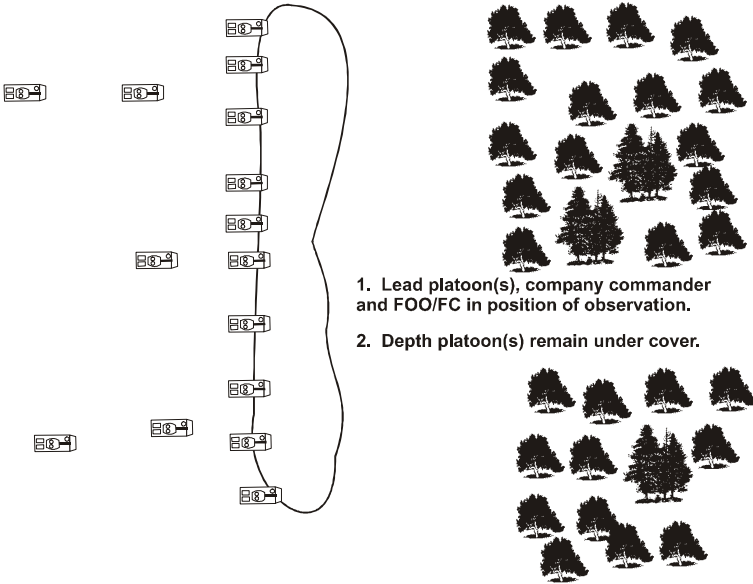
b. **Defile Drill—Defile not Cleared by Dismounted Infantry:**

- (1) **Warning.** The lead elements on the company report **HELD-UP—LONG/SHORT DEFILE** and move into a position of observation.
- (2) **Security.** The remainder of the company moves into a covered location, and the lead element ensures that it can quickly move from positions of observation overlooking the defile to positions of fire.
- (3) **Recce.** The company commander and the FOO/FC move to a position overlooking the defile.
- (4) **Plan/Execution.** The company commander decides he will not clear the defile with dismounted infantry.

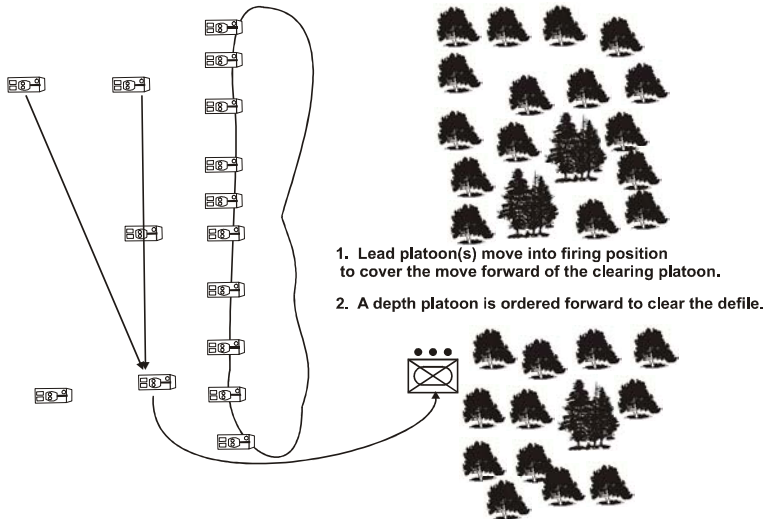
- (a) The company commander orders one of the depth platoons to clear the defile mounted.
- (b) The lead element moves from positions of observation to fire positions and prepares to cover the move of the clearing platoon.
- (c) The clearing platoon moves mounted to the mouth of the defile.
- (d) The clearing platoon clears the defile using either successive or alternate bounds, depending on the ground and the platoon commander's assessment. The number of LAVs forward—one or two—depends on the ground.
- (e) If the defile is wide enough to allow two LAVs forward, then the turrets usually cover the frontal arc while soldiers in the air sentry hatch cover to the sides and rear. If the platoon has only one vehicle forward, then the two rear vehicles will usually cover alternate sides of the defile with their turrets.
- (f) Once the lead platoon has exited the defile, it takes up fire positions. The remainder of the company then moves through, one platoon at a time, and moves one bound past the defile.

**NOTE**

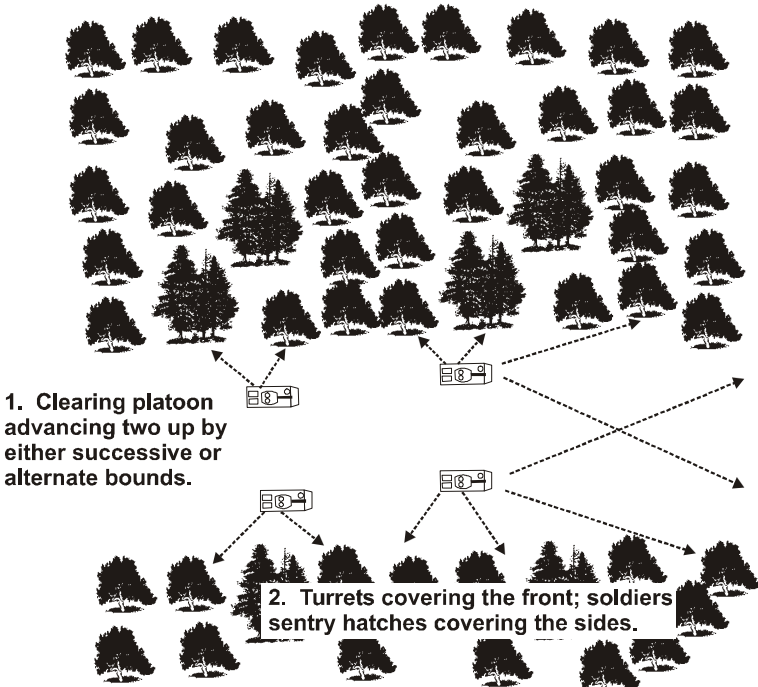
In the example given below, if the platoon were clearing a long defile, the FOO/FC and engr elements would follow the clearing platoon.



**Figure 5A-14: Defile Drill—Defile not Cleared with Dismounted Infantry—Part 1**

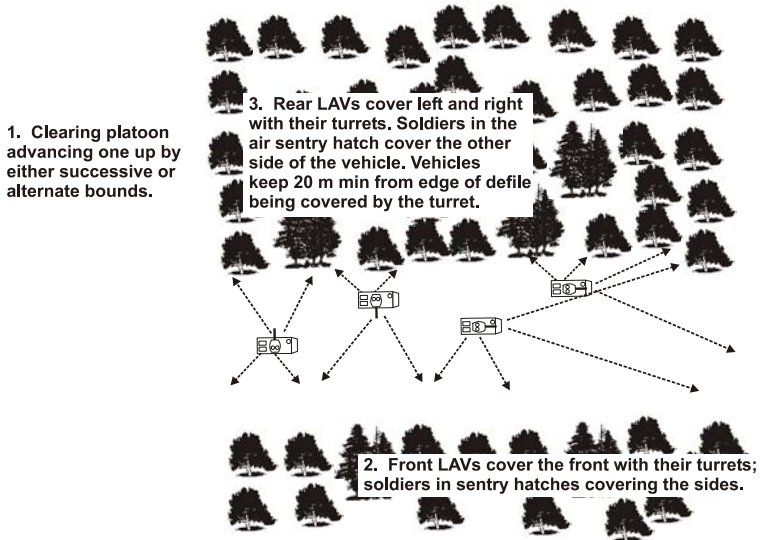


**Figure 5A-15: Defile Drill—Defile not Cleared with Dismounted Infantry—Part 2**



**Figure 5A-16: Defile Drill—Defile not Cleared by Dismounted Infantry—Part 3—Two Vehicles Forward**





**Figure 5A-17: Defile Drill—Defile not Cleared with Dismounted Infantry—Part 3—One Vehicle Forward**

8. **Blind Corner Drills—General.** Blind corners are most likely to be encountered during long defile drills. They are usually cleared dismounted but can be cleared mounted if the commander judges the risk to be worth the savings in time. Clearing dismounted takes more time but is more secure. Smoke and speculative fire can be used at any stage of the drill if the commander deems it appropriate and the circumstances permit.

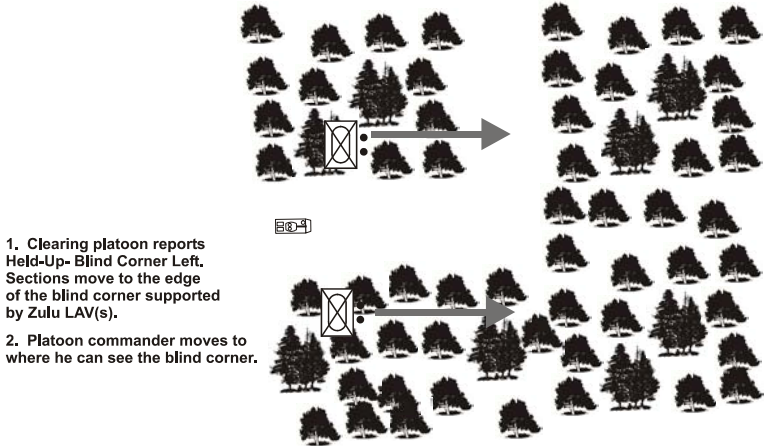
a. **Blind Corner Left or Right Drill—Defile Being Cleared Dismounted, Blind Corner Cleared Dismounted:**

- (1) **Warning.** Lead element reports **HELD-UP—BLIND CORNER LEFT/RIGHT.**
- (2) **Security.** Clearing sections adopt fire positions at the edge of the corner. The Zulu LAV(s) moves forward to cover as much of the corner as they can without going past the corner. Zulu LAV(s) is also prepared to fire smoke, if necessary, to

LAV Company Tactics (Interim)

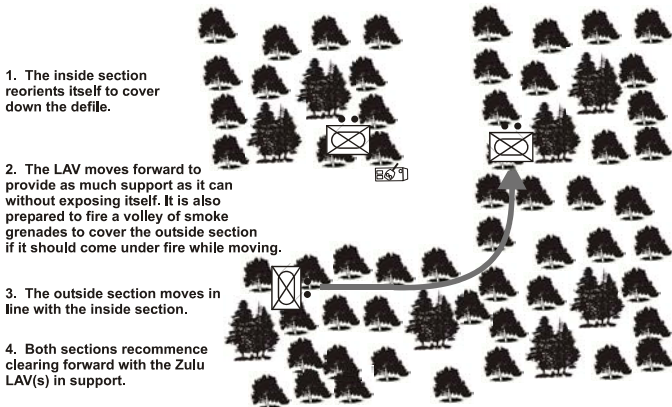
blind any enemy who may be covering the corner.

- (3) **Recce.** Platoon commander moves forward to the edge of the corner and observes as best he can.
- (4) **Plan / Execution.** The platoon commander decides to clear the blind corner dismounted:
  - (a) The inside section reorients itself, if necessary, to ensure it is covering around the inside corner and across the defile.
  - (b) The outside section clears around the corner until it is even with the inside section.
  - (c) The Zulu LAV(s) is prepared to fire smoke to blind the enemy should the outside section come under fire from further down the defile.
  - (d) Once the outside section has come level with the inside section, both sections carry on with clearing the defile. Once the sections have cleared past the corner, the Zulu LAV(s) recommences moving to support the dismounted sections.



1. Clearing platoon reports Held-Up- Blind Corner Left. Sections move to the edge of the blind corner supported by Zulu LAV(s).
2. Platoon commander moves to where he can see the blind corner.

**Figure 5A-18: Blind Corner Left/Right Drill—Defile and Blind Corner Cleared with Dismounted Infantry—Part 1**



1. The inside section reorients itself to cover down the defile.
2. The LAV moves forward to provide as much support as it can without exposing itself. It is also prepared to fire a volley of smoke grenades to cover the outside section if it should come under fire while moving.
3. The outside section moves in line with the inside section.
4. Both sections recommence clearing forward with the Zulu LAV(s) in support.

**Figure 5A-19: Blind Corner Left/Right Drill—Defile and Blind Corner Cleared with Dismounted Infantry—Part 2**

**b. Blind Corner Left or Right Drill—Defile Not Cleared with Dismounted Infantry, Blind Corner Cleared with Dismounted Infantry:**

- (1) **Warning.** The lead element reports **HELD-UP, BLIND CORNER LEFT/RIGHT.**

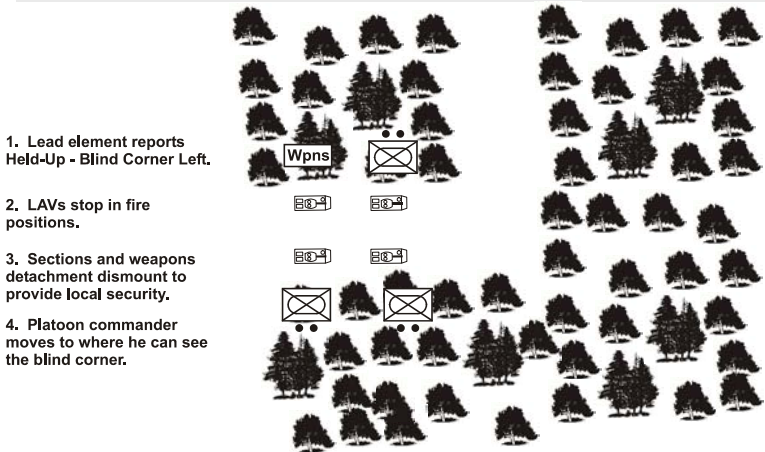
LAV Company Tactics (Interim)

- (2) **Security.** The LAVs stop in fire positions. The sections and platoon headquarters weapons detachment dismount, move into the woods and cover the left and right of the defile.
- (3) **Recce.** The platoon commander moves, if necessary, to where he can see the blind corner.
- (4) **Plan / Execution.** The platoon commander decides to clear the blind corner dismounted:
  - (a) The platoon commander orders two sections to clear the blind corner.
  - (b) The inside section reorients itself, if necessary, to ensure it is covering around the inside corner and across the defile.
  - (c) The outside section clears around the corner until it is even with the inside section.
  - (d) The Zulu LAV(s) is prepared to fire smoke to blind the enemy should the outside section come under fire from further down the defile.
  - (e) The sections continue clearing down the defile until the platoon commander is decides the blind corner is clear. They then halt in fire positions.
  - (f) The soldiers providing local security for the LAVs mount and the LAVs move round the corner in bounds.

- (g) The LAVs stop momentarily as they come up to the clearing section to allow the sections to mount.
- (h) The platoon continues clearing the defile.

**NOTE**

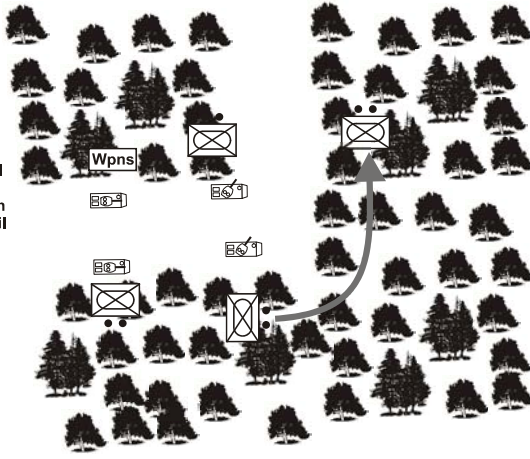
In the example below, the LAVs are clearing two LAVs leading. Depending on the circumstances, it could be one LAV leading.



**Figure 5A-20: Blind Corner Left/Right Drill—Defile not Cleared with Dismounted Infantry, Blind Corner Cleared with Dismounted Infantry—Part 1**

## LAV Company Tactics (Interim)

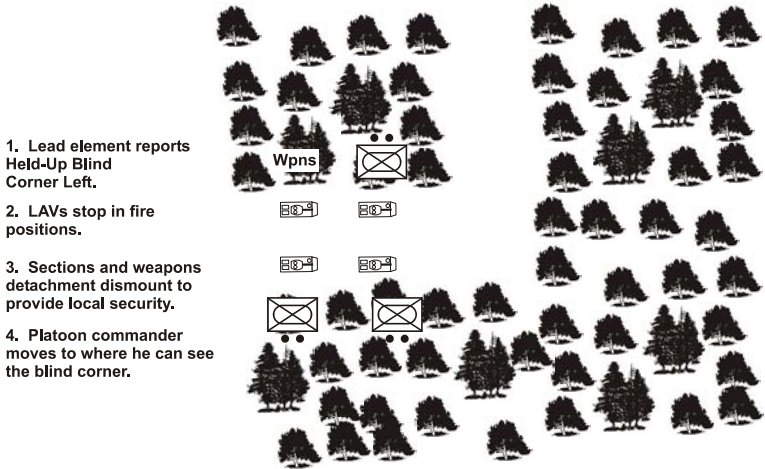
1. Front LAVs move to cover the blind corner. They are also prepared to fire smoke to blind any enemy.
2. Inside clearing section reorients itself, if necessary.
3. Outside clearing section moves around the corner until even with the inside clearing section. The two sections then continue to move forward until the platoon commander is satisfied the blind corner is clear.
4. The rear section and weapons detachment mount and the LAVs round the corner in bounds.
5. The LAVs stop momentarily by the forward sections and they mount.



**Figure 5A-21: Blind Corner Left/Right Drill—Defile not Cleared with Dismounted Infantry, Blind Corner Cleared with Dismounted Infantry—Part 2**

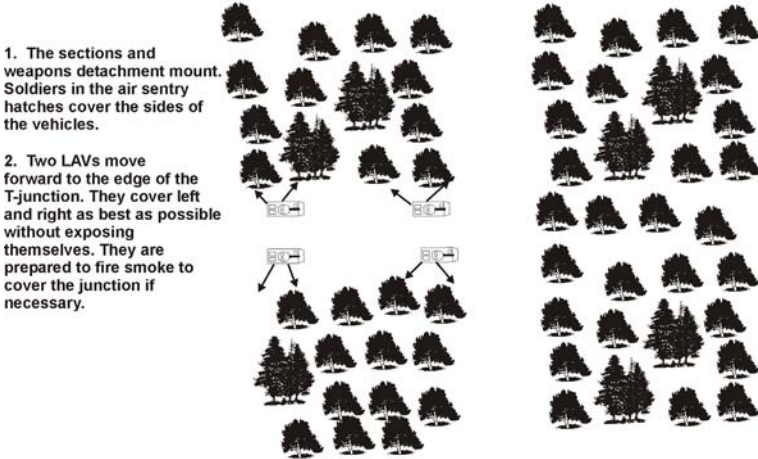
- c. **Blind Corner Left or Right Drill—Defile and Blind Corner not Cleared with Dismounted Infantry:**
- (1) **Warning.** Lead element reports **HELD-UP BLIND CORNER LEFT/RIGHT.**
  - (2) **Security.** LAVs stop in fire positions. Sections and weapons detachment dismount for local security.
  - (3) **Recce.** The platoon commander moves to where he can see the blind corner.
  - (4) **Plan / Execution.** The platoon commander orders the lead LAVs to clear the defile mounted:
    - (a) The front LAVs mount their infantry and move so they can cover as much of the blind corner as possible without exposing themselves. Infantry in the air sentry hatches cover left and right.

- (b) The front two LAVs move around the corner and take up fire positions. They report the corner clear.
- (c) The rear two LAVs mount their infantry, and the advance continues.



**Figure 5A-22: Blind Corner Left/Right Drill—Defile and Blind Corner not Cleared with Dismounted Infantry—Part 1**

## LAV Company Tactics (Interim)

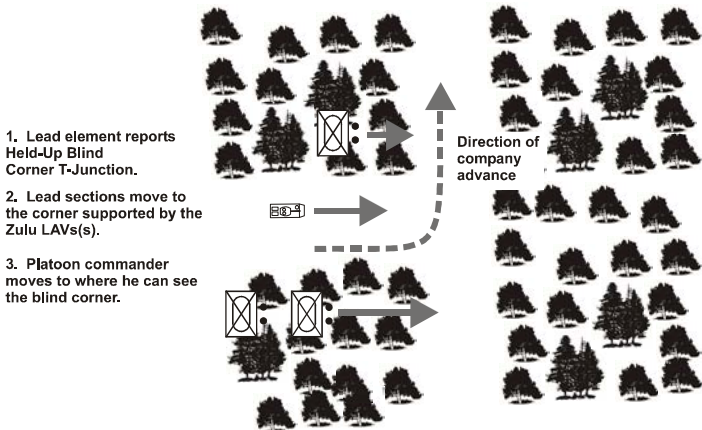


**Figure 5A-23: Blind Corner Left/Right Drill—Defile and Blind Corner not Cleared with Dismounted Infantry—Part 2**

- d. **Blind Corner T-Junction Drill—Defile and Blind Corner Cleared with Dismounted Infantry:**
- (1) **Warning.** Lead element reports **HELD-UP—BLIND CORNER T-JUNCTION.**
  - (2) **Security.** Clearing sections adopt fire positions at the edge of the corner. Zulu LAV(s) moves forward to cover as much of the corner as they can without going past the corner. The Zulu LAV(s) is also prepared to fire smoke if necessary to blind any enemy who may be covering the corner.
  - (3) **Recce.** Platoon commander moves forward to the edge of the corner and observes as best he can.
  - (4) **Plan / Execution:**
    - (a) The two lead sections reorient themselves, if necessary, to cover across the defile and around the corners.

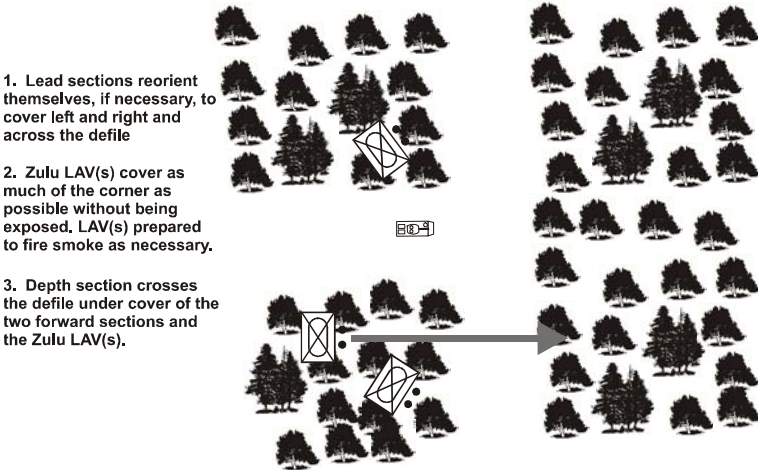


- (b) The depth section moves up under cover to the corner on the side opposite to which the company will turn—if the company is turning left at the T-junction, the depth section goes to the right-hand side.
- (c) Under cover of the two lead sections and the Zulu LAV(s), the depth section crosses the road and begins clearing in the direction the company will turn. When the section comes level with the section on the opposite side of the defile, the two sections clear forward until the platoon commander is satisfied the T-junction is clear.
- (d) The Zulu LAV(s) and the remaining section round the corner and the defile drill continues.



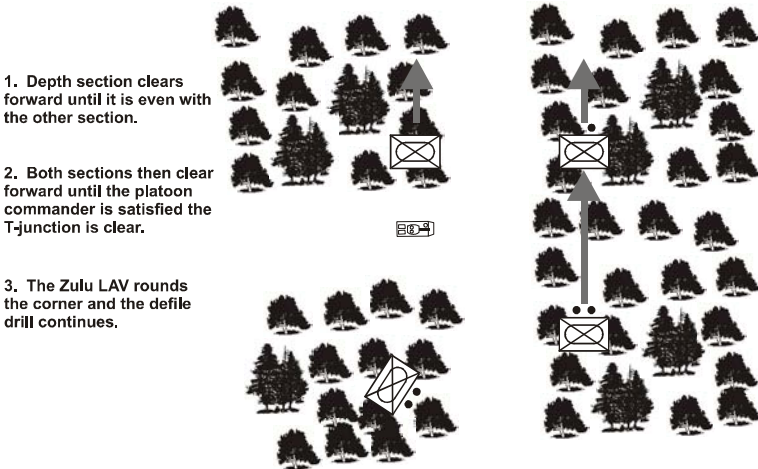
**Figure 5A-24: Blind Corner T-Junction Drill—Defile and Blind Corner Cleared with Dismounted Infantry—Part 1**

LAV Company Tactics (Interim)



1. Lead sections reorient themselves, if necessary, to cover left and right and across the defile
2. Zulu LAV(s) cover as much of the corner as possible without being exposed. LAV(s) prepared to fire smoke as necessary.
3. Depth section crosses the defile under cover of the two forward sections and the Zulu LAV(s).

**Figure 5A-25: Blind Corner T-Junction Drill—Defile and Blind Corner Cleared with Dismounted Infantry—Part 2**



1. Depth section clears forward until it is even with the other section.
2. Both sections then clear forward until the platoon commander is satisfied the T-junction is clear.
3. The Zulu LAV rounds the corner and the defile drill continues.

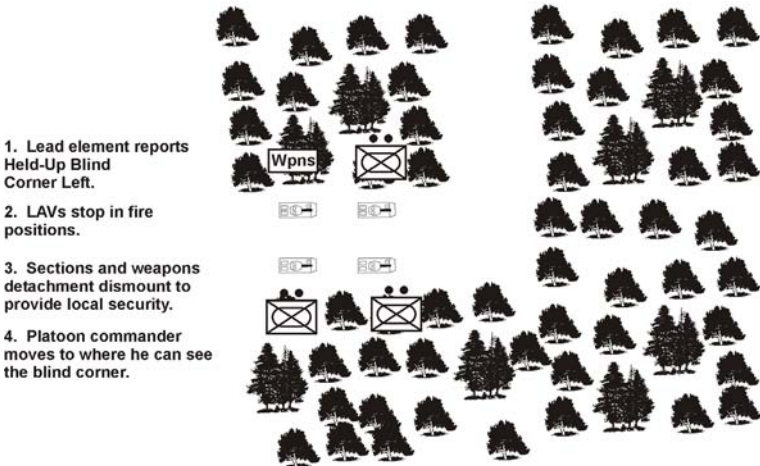
**Figure 5A-26: Blind Corner T-Junction Drill—Defile and Blind Corner Cleared with Dismounted Infantry—Part 3**

- e. **Blind Corner T-Junction Drill—Defile not Cleared with Dismounted Infantry, Blind Corner Cleared with Dismounted Infantry:**
  - (1) **Warning.** Lead element reports **HELD-UP—BLIND CORNER T-JUNCTION.**

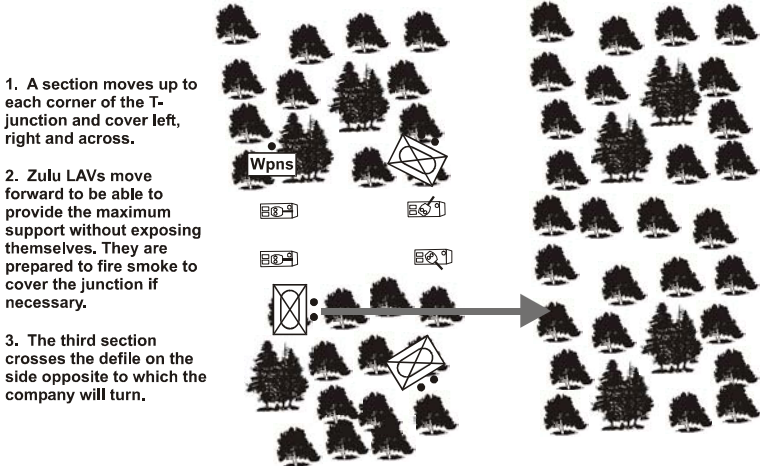
- (2) **Security.** The LAVs stop in fire positions. The sections and platoon headquarters weapons detachment dismount, move into the woods and cover the left and right of the defile.
- (3) **Recce.** The platoon commander moves, if necessary, to where he can see the blind corner.
- (4) **Plan / Execution.** The platoon commander decides to clear the defile dismounted:
  - (a) Two sections, one on either side of the defile, move to the corner and cover left and right and across the defile.
  - (b) The Zulu LAV(s) moves forward to where they can provide the maximum support without exposing themselves. The Zulu LAV(s) is prepared to fire smoke.
  - (c) The remaining section moves to the corner on the side opposite to the direction the company will travel. It crosses the defile under cover of the other sections and the Zulu LAV(s).
  - (d) The section that crossed the road now clears forward, along the company's route, until it is opposite the section on the other side of the road. Both sections then clear forward until the platoon commander is satisfied that the T- junction is clear.

LAV Company Tactics (Interim)

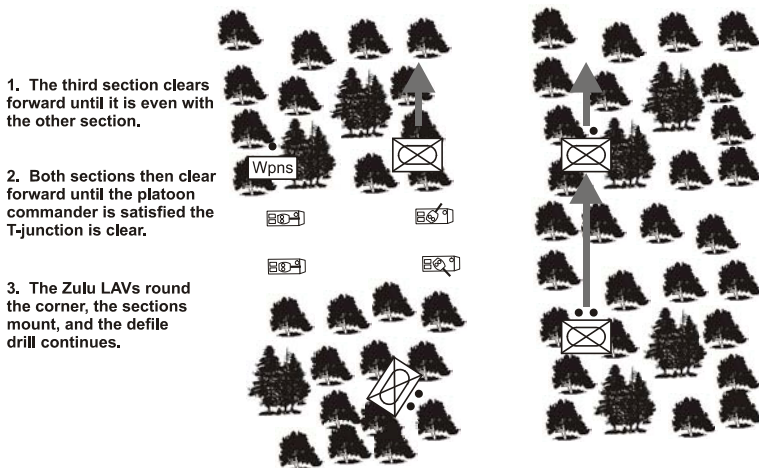
(e) The LAVs move forward, the sections mount, and the defile drill continues.



**Figure 5A-27: Blind Corner T-Junction Drill—Defile not Cleared with Dismounted Infantry, Blind Corner Cleared with Dismounted Infantry—Part 1**



**Figure 5A-28: Blind Corner T-Junction Drill—Defile not Cleared with Dismounted Infantry, Blind Corner Cleared with Dismounted Infantry—Part 2**

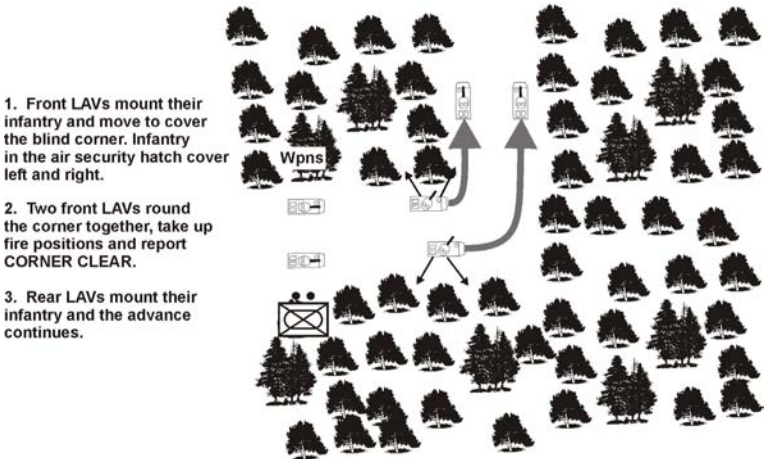


**Figure 5A-29: Blind Corner T-Junction Drill—Defile not Cleared with Dismounted Infantry, Blind Corner Cleared with Dismounted Infantry—Part 3**

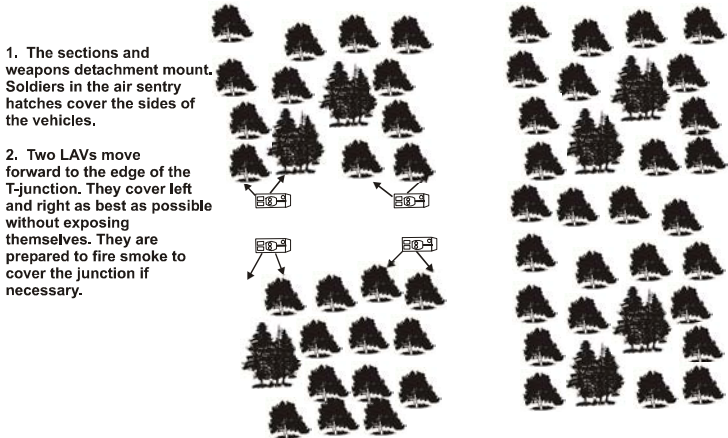
- f. **Blind Corner T-Junction Drill—Defile and Blind Corned not Cleared with Dismounted Infantry:**
- (1) **Warning.** Lead element reports **HELD-UP—BLIND CORNER T-JUNCTION.**
  - (2) **Security.** The LAVs stop in fire positions. The sections and platoon headquarters weapons detachment dismount, move into the woods and cover the left and right of the defile.
  - (3) **Recce.** The platoon commander moves, if necessary, to where he can see the blind corner.
  - (4) **Plan / Execution.** The platoon commander decides he will not clear the blind corner with dismounted infantry:
    - (a) The sections and weapons detachment mount. Soldiers in the air sentry hatches cover the sides of each vehicle.

LAV Company Tactics (Interim)

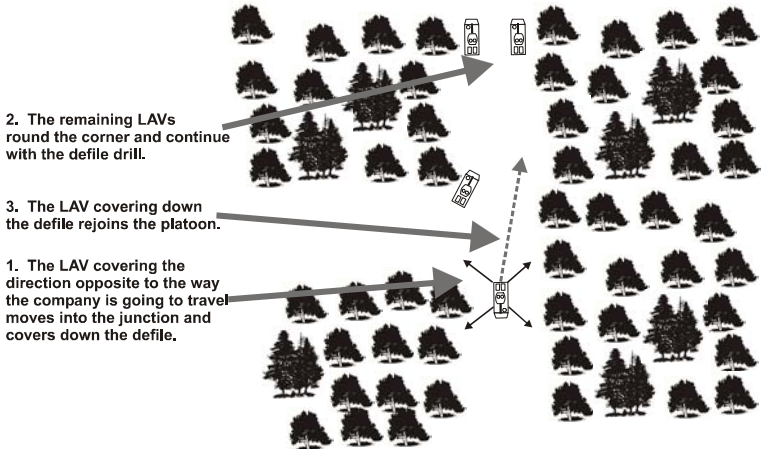
- (b) The first two LAVs move to the T-junction and cover left and right as much as possible without going past the corner. Both LAVs are prepared to fire smoke if necessary.
- (c) The LAV covering the direction opposite to the way the company is going to travel (the right-hand LAV if the company is turning left and the left-hand LAV if the company is turning right) moves into the junction to cover down the defile.
- (d) The other LAVs turn the corner and continue with the defile drill. The LAV covering down the defile then moves to join them.



**Figure 5A-30: Blind Corner T-Junction Drill—Defile and Blind Corner not Cleared with Dismounted Infantry—Part 1**



**Figure 5A-31: Blind Corner T-Junction Drill—Defile and Blind Corner not Cleared with Dismounted Infantry—Part 2**



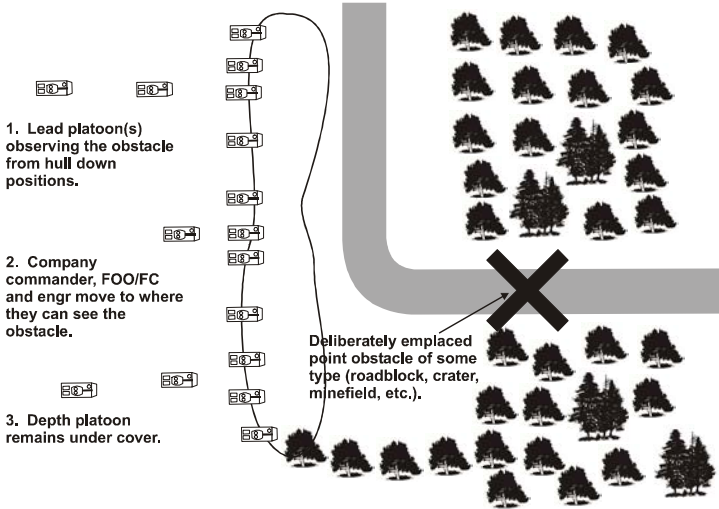
**Figure 5A-32: Blind Corner T-Junction Drill—Defile and Blind Corner not Cleared with Dismounted Infantry—Part 3**

9. **Deliberately Emplaced Point Obstacle Drill.** A deliberately emplaced obstacle is normally covered by fire, direct or indirect. As such, the possibility of bypassing the obstacle must be examined. If bypass is not practical, or in the opinion of the commander it would simply lead the force into an even more dangerous situation, then the use of speculative fire and smoke should be considered before committing troops to the clearing of the obstacle.

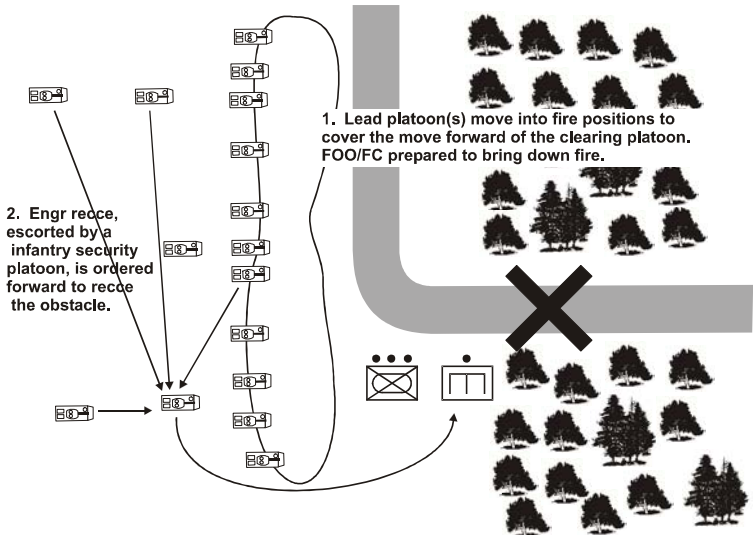
LAV Company Tactics (Interim)

- a. **Warning.** The lead element reports **CONTACT ROADBLOCK** (or **MINEFIELD**, etc., depending on the type of obstacle).
- b. **Security.** The company moves into concealed locations (turret-down) while keeping observation on the obstacle.
- c. **Recce.** The company commander, FOO/FC and engr move into a position of observation.
- d. **Plan / Execution.** The company commander decides that the obstacle cannot be avoided and must be breached:
  - (1) Two platoons move into fire positions covering the obstacle.
  - (2) The FOO/FC is prepared to bring down high explosives (HE) or smoke if necessary.
  - (3) An engr recce party moves down to the obstacle with a rifle platoon for protection.
  - (4) The engr party determines what time and resources are required to clear the obstacle.
  - (5) If the company has the necessary engineering resources, they move down to the obstacle, clear it, and the advance continues.
  - (6) If the company does not have the resources needed, it must get them from higher or find an alternate route. Based on his risk management, the commander may simply force the obstacle, accepting the resultant casualties.





**Figure 5A-33: Deliberately Emplaced Point Obstacle Drill—Part 1**



**Figure 5A-34: Deliberately Emplaced Point Obstacle Drill—Part 2**



**CHAPTER 6  
ADMINISTRATION**

To be issued.